



INSTRUCTION MANUAL

Flammable Liquid Presence Detector
Interface Relay Output
DIN-Rail Model D1180D



Characteristics

General Description: The Flammable Liquid Presence Detector Interface type D1180D is a DIN Rail unit configurable with two isolated independent channels.

The unit can be configured for NPN or PNP transistor type input, NO or NC and for NE or ND SPDT relay output.

Each channel enables a Safe Area load to be controlled by 3 wires opto-electronic sensors or 3 wires proximity sensors located in Hazardous Area.

Function: 2 channels I.S. flammable liquid presence detector interface or 3 wires proximity sensor. Provides 3 port isolation (input/output/supply).

Signalling LEDs: Power supply indication (green), output status (yellow).

Field Configurability: NO/NC input for sensor transistor input, NE/ND relay operation, switching current levels.

EMC: Fully compliant with CE marking applicable requirements.

Technical Data

Supply:

115-230 Vac, 50-60 Hz nom (85 to 264 Vac, 48 to 400 Hz) or 100 to 350 Vdc, ripple within voltage limits ≤ 10 Vpp. Limit supply voltage to 250 Vrms for Intrinsic Safety applications.

Current consumption @ 115 Vac: 30 mA with short input and relays energized.

Current consumption @ 230 Vac: 20 mA with short input and relays energized.

Max. power consumption: at 264 Vac supply voltage, short circuit input and relays energized, 2.2 W.

Isolation (Test Voltage): I.S. In/Out 2.5 KV; I.S. In/Supply 2.5 KV; I.S. In/I.S. In 500 V; Out/Supply 2.5 KV; Out/Out 2.5 KV.

Input switching current levels: DIP switch settable at $\approx 8.0, 11.0, 14.0, 17.0$ mA trip point. Sensor supply current range is 0 to 5, 3 to 8, 6 to 11, 9 to 14 mA, switching current ≈ 8.0 mA ± 0.5 mA hysteresis.

Input equivalent source: 13.0 V 150 Ω typical (13 V no load, 25 mA short circuit limited current).

Output: voltage free SPDT relay contact.

Contact material: AgCdO.

Contact rating: 2 A 250 Vac 500 VA, 2 A 250 Vdc 80 W (resistive load).

DC Load breaking capacity:

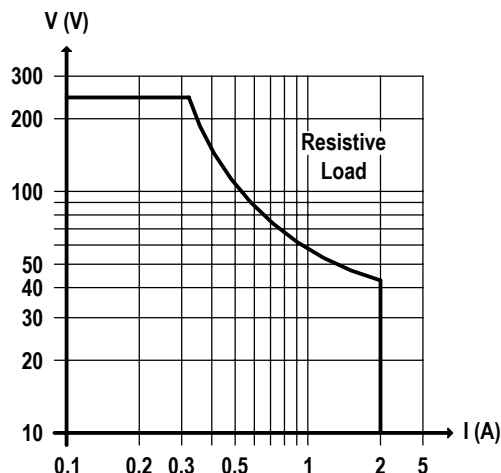

Mechanical / Electrical life: $30 * 10^6 / 1 * 10^9$ operation, typical.

Operate / Release time: 7 / 3 ms typical.

Bounce time NO / NC contact: 3 / 5 ms.

Response time: 20 ms.

Frequency response: 10 Hz maximum.

Compatibility:

CE CE mark compliant, conforms to 94/9/EC ATEX Directive and to 2004/108/CE EMC Directive.

Environmental conditions: Operating: temperature limits -20 to +60 °C, relative humidity max 90 % non condensing, up to 35 °C.

Storage: temperature limits -45 to +80 °C.

Safety Description:



II (1) G [Ex ia Ga] IIC, II (1) D [Ex ia Da] IIIC, I (M1) [Ex ia Ma] I, [Ex ia Ga] IIC, [Ex ia Da] IIIC, [Ex ia Ma] I associated electrical apparatus.

Uo/Voc = 15.8 V, Io/Isc = 109 mA, Po/Po = 428 mW at terminals 13-16, 9-12.

Uo/Voc = 15.8 V, Io/Isc = 13 mA, Po/Po = 51 mW at terminals 14-16, 13-15, 10-12, 9-11.

Um = 250 Vrms, -20 °C \leq Ta \leq 60 °C.

Approvals: DMT 01 ATEX E 042 X conforms to EN60079-0, EN60079-11, EN60079-26, EN61241-0, EN61241-11,

IECEx BVS 07.0027X conforms to IEC60079-0, IEC60079-11, IEC60079-26, IEC61241-0, IEC61241-11,

Russia according to GOST 12.2.007.0-75, R 51330.0-99, R 51330.10-99 [Exia] IIC X, Ukraine according to GOST 12.2.007.0,22782.0,22782.5 Exia IIC X,

KR Type Approval Certificate for marine applications.

Mounting: T35 DIN Rail according to EN50022.

Weight: about 160 g.

Connection: by polarized plug-in disconnect screw terminal blocks to accommodate terminations up to 2.5 mm².

Location: Safe Area installation.

Protection class: IP 20.

Dimensions: Width 22.5 mm, Depth 99 mm, Height 114.5 mm.

Ordering information

Model: D1180D

Front Panel and Features

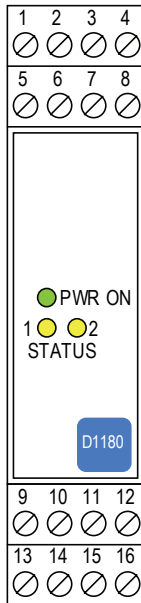

- Input from Zone 0 (Zone 20).
- Universal AC supply voltage (85 to 264 Vac or 100 to 350 Vdc).
- Dual channel Flammable Liquid Presence Detector Interface Input.
- NPN/PNP 3 wires proximity Detector Input.
- Two SPDT Relay Output Signals.
- Three port isolation, Input/Output/Supply.
- EMC Compatibility to EN61000-6-2, EN61000-6-4.
- In-field programmability by DIP Switch.
- ATEX, IECEx, Russian and Ukrainian Certifications.
- Type Approval Certificate KR for marine applications.
- High Reliability, SMD components.
- High Density, two channels per unit.
- Simplified installation using standard DIN Rail and plug-in terminal blocks.
- 250 Vrms (Um) max. voltage allowed to the instruments associated with the barrier.

Terminal block connections

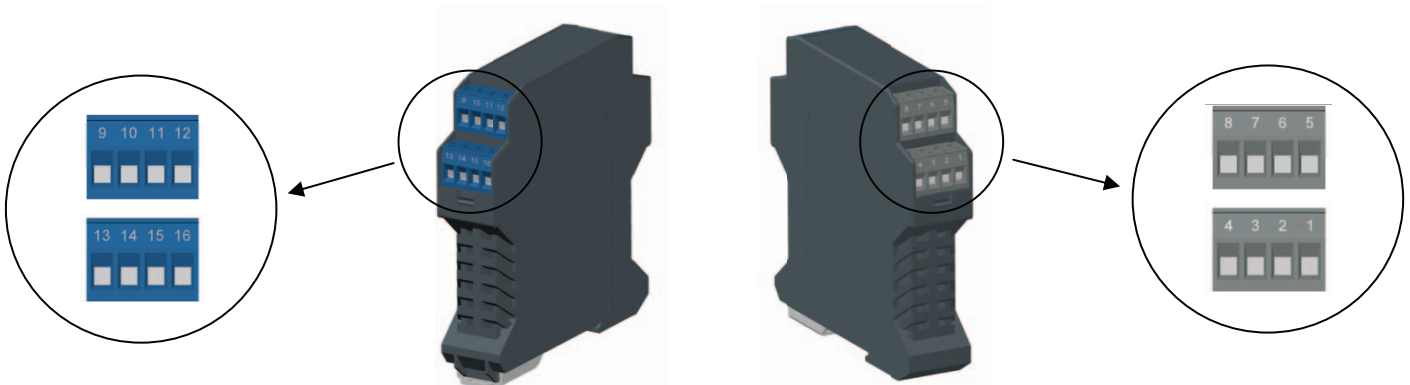

HAZARDOUS AREA

9	+ Input Ch 2 for 3 wire Sensor
10	Input Ch 2 for 3 wire Sensor (Collector)
11	Input Ch 2 for 3 wire Sensor (Emitter)
12	- Input Ch 2 for 3 wire Sensor
13	+ Input Ch 1 for 3 wire Sensor
14	Input Ch 1 for 3 wire Sensor (Collector)
15	Input Ch 1 for 3 wire Sensor (Emitter)
16	- Input Ch 1 for 3 wire Sensor

SAFE AREA

1	Output Ch1 Common
2	Output Ch1 Relay Normally Opened (NO)
3	L Power Supply 115-230 Vca
4	N Power Supply 115-230 Vca
5	Output Ch2 Common
6	Output Ch2 Relay Normally Opened (NO)
7	Output Ch2 Relay Normally Closed (NC)
8	Output Ch1 Relay Normally Closed (NC)

Parameters Table

In the system safety analysis, always check the Hazardous Area devices to conform with the related system documentation, if the device is Intrinsically Safe check its suitability for the Hazardous Area and gas group encountered and that its maximum allowable voltage, current, power (U_i/V_{max} , I_i/I_{max} , P_i/P_i) are not exceeded by the safety parameters (U_o/V_o , I_o/I_o , P_o/P_o) of the D1180 Associated Apparatus connected to it. Also consider the maximum operating temperature of the field device, check that added connecting cable and field device capacitance and inductance do not exceed the limits (C_o/C_a , L_o/L_a , L_o/R_o) given in the Associated Apparatus parameters for the effective gas group. See parameters on enclosure side and the ones indicated in the table below:

D1180 Terminals		D1180 Associated Apparatus Parameters		Must be	Hazardous Area Device Parameters
Ch1	13 - 16	$U_o / V_o = 15.8 \text{ V}$		\leq	U_i / V_{max}
Ch2	9 - 12				
Ch1	14 - 16, 13 - 15	$U_o / V_o = 15.8 \text{ V}$		\leq	U_i / V_{max}
Ch2	10 - 12, 9 - 11				
Ch1	13 - 16	$I_o / I_o = 109 \text{ mA}$		\leq	I_i / I_{max}
Ch2	9 - 12				
Ch1	14 - 16, 13 - 15	$I_o / I_o = 13 \text{ mA}$		\leq	I_i / I_{max}
Ch2	10 - 12, 9 - 11				
Ch1	13 - 16	$P_o / P_o = 428 \text{ mW}$		\leq	P_i / P_i
Ch2	9 - 12				
Ch1	14 - 16, 13 - 15	$P_o / P_o = 51 \text{ mW}$		\leq	P_i / P_i
Ch2	10 - 12, 9 - 11				
D1180 Terminals		D1180 Associated Apparatus Parameters		Must be	Hazardous Area Device + Cable Parameters
Ch1	13 - 16	$C_o / C_a = 478 \text{ nF}$	(IIC-A, B)	\geq	$C_i / C_i \text{ device} + C \text{ cable}$
Ch2	9 - 12	$C_o / C_a = 2.88 \mu\text{F}$	(IIB-C)		
Ch1	14 - 16, 13 - 15	$C_o / C_a = 11.6 \mu\text{F}$	(IIA-D)		
Ch2	10 - 12, 9 - 11	$C_o / C_a = 11.6 \mu\text{F}$	(IIA-D)		
Ch1	13 - 16	$L_o / L_a = 3 \text{ mH}$	(IIC-A, B)	\geq	$L_i / L_i \text{ device} + L \text{ cable}$
Ch2	9 - 12	$L_o / L_a = 12 \text{ mH}$	(IIB-C)		
Ch1	14 - 16, 13 - 15	$L_o / L_a = 217.6 \text{ mH}$	(IIC-A, B)		
Ch2	10 - 12, 9 - 11	$L_o / L_a = 870.7 \text{ mH}$	(IIB-C)		
Ch1	13 - 16	$L_o / R_o = 83 \mu\text{H}/\Omega$	(IIC-A, B)	\geq	$L_i / R_i \text{ device and } L \text{ cable} / R \text{ cable}$
Ch2	9 - 12	$L_o / R_o = 332 \mu\text{H}/\Omega$	(IIB-C)		
Ch1	14 - 16, 13 - 15	$L_o / R_o = 706 \mu\text{H}/\Omega$	(IIC-A, B)		
Ch2	10 - 12, 9 - 11	$L_o / R_o = 2820 \mu\text{H}/\Omega$	(IIB-C)		
Ch1	13 - 16	$L_o / R_o = 83 \mu\text{H}/\Omega$	(IIC-A, B)	\geq	$L_i / R_i \text{ device and } L \text{ cable} / R \text{ cable}$
Ch2	9 - 12	$L_o / R_o = 332 \mu\text{H}/\Omega$	(IIB-C)		
Ch1	14 - 16, 13 - 15	$L_o / R_o = 706 \mu\text{H}/\Omega$	(IIC-A, B)		
Ch2	10 - 12, 9 - 11	$L_o / R_o = 2820 \mu\text{H}/\Omega$	(IIB-C)		

For installations in which both the C_i and L_i of the Intrinsically Safe apparatus exceed 1 % of the C_o and L_o parameters of the Associated Apparatus (excluding the cable), then 50 % of C_o and L_o parameters are applicable and shall not be exceeded (50 % of the C_o and L_o become the limits which must include the cable such that $C_i \text{ device} + C \text{ cable} \leq 50 \% \text{ of } C_o$ and $L_i \text{ device} + L \text{ cable} \leq 50 \% \text{ of } L_o$).

If the cable parameters are unknown, the following value may be used: Capacitance 60pF per foot (180pF per meter), Inductance 0.20μH per foot (0.60μH per meter).

Function Diagram

HAZARDOUS AREA ZONE 0 (ZONE 20) GROUP IIC

SAFE AREA

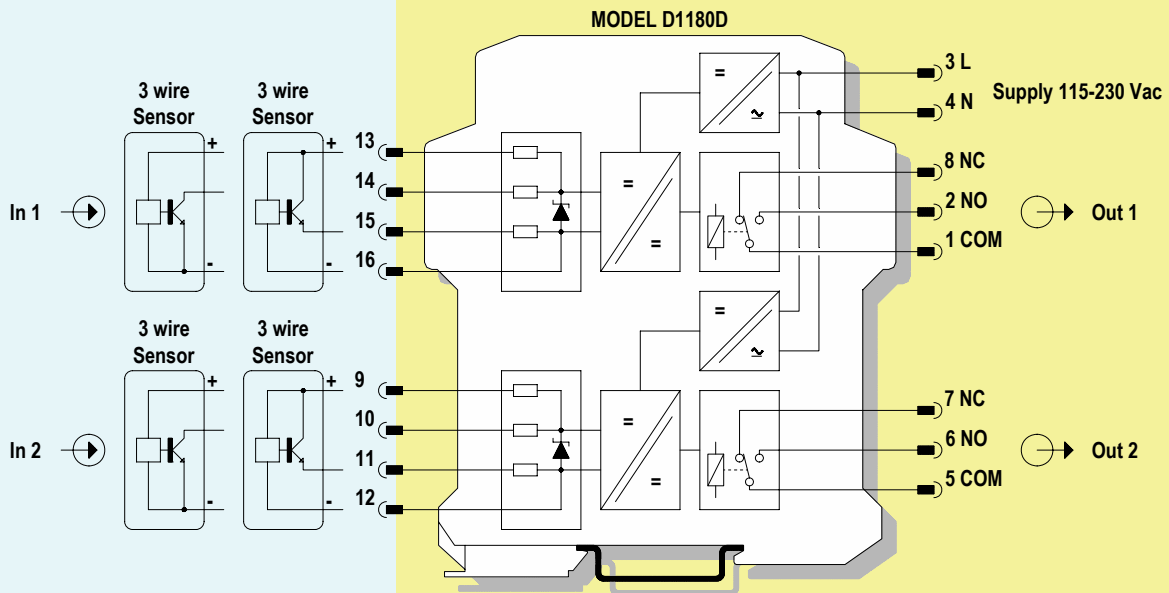

Warning

D1180 is an isolated Intrinsically Safe Associated Apparatus installed into standard EN50022 T35 DIN Rail located in Safe Area within the specified operating temperature limits

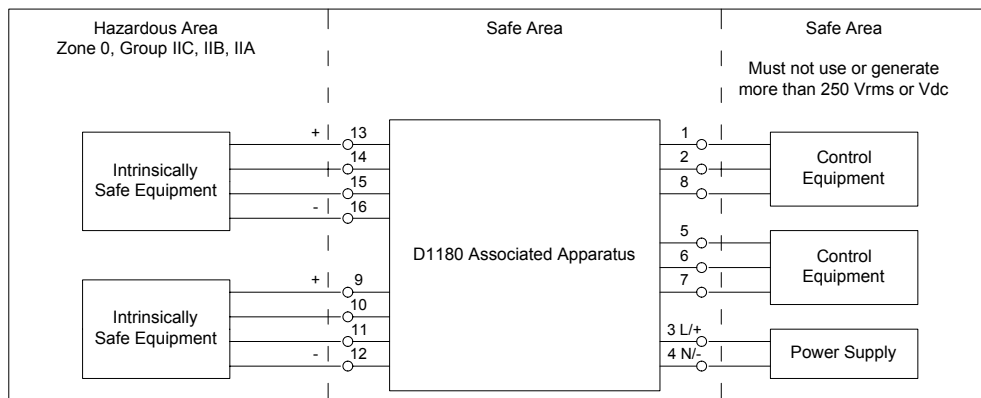

Tamb -20 to +60 °C, and connected to equipment with a maximum limit for AC power supply Um of 250 Vrms.

Not to be connected to control equipment that uses or generates more than 250 Vrms or Vdc with respect to earth ground (the unit can be connected up to 264 Vrms or 350 Vdc in non intrinsic safety installation).

D1180 must be installed, operated and maintained only by qualified personnel, in accordance to the relevant national/international installation standards

(e.g. IEC/EN60079-14 Electrical apparatus for explosive gas atmospheres - Part 14: Electrical installations in hazardous areas (other than mines), BS 5345 Pt4, VDE 165) following the established installation rules, particular care shall be given to segregation and clear identification of I.S. conductors from non I.S. ones.

Warning: substitution of components may impair Intrinsic Safety.

Warning: de-energize main power source (turn off power supply voltage) and disconnect plug-in terminal blocks before opening the enclosure to avoid electrical shock when connected to live hazardous potential.

Explosion Hazard: to prevent ignition of flammable or combustible atmospheres, disconnect power before servicing or unless area is known to be nonhazardous.

Failure to properly installation or use of the equipment may risk to damage the unit or severe personal injury.

Operation

D1180 accepts as an input from Hazardous Area a liquid sensor detector with PNP or NPN transistor output. It also interfaces 3 wire proximity sensor with PNP or NPN output and repeats their status to Safe Area by a voltage free SPDT relay contact.

Presence of supply power and status of output (energized or de-energized) are displayed by signaling LEDs (green for power, yellow for status).

D1180D (dual channel type) has two independent and isolated input channels and actuates the corresponding output relay SPDT contact;

two actuation modes can be independently DIP switch configured for each input channel:

Normally open input / Normally energized relay or Normally close input / Normally energized relay Input sensor current consumption is also DIP switch settable in four position, which correspond a total trip current of 8, 11, 14 and 17 mA (current flow in transistor sensor is setted at \approx 8 mA).

Installation

D1180 is an AC supply liquid presence detector interfaces housed in a plastic enclosure suitable for installation on T35 DIN Rail according to EN50022.

D1180 unit can be mounted with any orientation over the entire ambient temperature range, see section "Installation in Cabinet" and "Installation of Electronic Equipments in Cabinet" Instruction Manual D1000 series for detailed instructions.

Electrical connection of conductors up to 2.5 mm² are accommodated by polarized plug-in removable screw terminal blocks which can be plugged in/out into a powered unit without suffering or causing any damage.

The wiring cables have to be proportionate in base to the current and the length of the cable.

On the section "Function Diagram" and enclosure side a block diagram identifies all connections and configuration DIP switches.

Identify the function and location of each connection terminal using the wiring diagram on the corresponding section, as an example:

Connect AC power supply (85 to 264 Vac, 48 to 400 Hz) or DC power supply (100 to 350 Vdc) at terminal "3" and "4" (limit supply voltage to Um 250 Vrms for Intrinsic Safety applications).

Connect common relay contact output of channel 1 at terminal "1", normally closed relay contact at "8" and normally opened relay contact at "2".

Connect common relay contact output of channel 2 at terminal "5", normally closed relay contact at "7" and normally opened relay contact at "6".

Connect sensor supply of channel 1 at terminal "13" for positive and "16" for negative.

Connect sensor supply of channel 2 at terminal "9" for positive and "12" for negative.

Connect sensor output of channel 1 at terminal "14" for NPN transistor output or at terminal "15" for PNP transistor type.

Connect sensor output of channel 2 at terminal "10" for NPN transistor output or at terminal "11" for PNP transistor type.

Intrinsically Safe conductors must be identified and segregated from non I.S. and wired in accordance to the relevant national/international installation standards

(e.g. EN/IEC60079-14 Electrical apparatus for explosive gas atmospheres - Part 14: Electrical installations in hazardous areas (other than mines), BS 5345 Pt4, VDE 165), make sure that conductors are well isolated from each other and do not produce any unintentional connection.

Connect SPDT relay contacts checking the load rating to be within the contact maximum rating (2 A, 250 V, 500 VA 80 W resistive load).

The enclosure provides, according to EN60529, an IP20 minimum degree of mechanical protection for indoor installation, outdoor installation requires an additional enclosure with higher degree of protection (i.e. IP54 to IP65) consistent with the effective operating environment of the specific installation.

Units must be protected against dirt, dust, extreme mechanical (e.g. vibration, impact and shock) and thermal stress, and casual contacts.

If enclosure needs to be cleaned use only a cloth lightly moistened by a mixture of detergent in water.

Electrostatic Hazard: to avoid electrostatic hazard, the enclosure of D1180 must be cleaned only with a damp or antistatic cloth.

Any penetration of cleaning liquid must be avoided to prevent damage to the unit. Any unauthorized card modification must be avoided.

According to EN61010, D1180 series must be connected to supply non exceeding category II, pollution degree II overvoltage limits.

Relay output contact must be connected to loads non exceeding category II, pollution degree II overvoltage limits.

Warning: de-energize main power source (turn off power supply voltage) and disconnect plug-in terminal blocks before opening the enclosure to avoid electrical shock when connected to live hazardous potential.

Start-up

Before powering the unit check that all wires are properly connected, particularly supply conductors and their polarity, input and output wires, also check that Intrinsically Safe conductors and cable trays are segregated (no direct contacts with other non I.S. conductors) and identified either by color coding, preferably blue, or by marking.

Check conductors for exposed wires that could touch each other causing dangerous unwanted shorts.

Turn on power, the "power on" green led must be lit, status led on each channel must be in accordance with condition of the corresponding input line.

If possible close and open input lines one at a time checking the corresponding status led condition as well as output to be correct.

Power Dissipation of D1180 Isolators

Section "Technical Data" of D1180 isolator specifies the current consumption (maximum current from the nominal power supply, typical 24 Vdc, in normal operation); this data serves to dimension the current rating of the power supply unit. Section "Technical Data" indicates also the maximum power consumption (maximum power required from the power supply in the worst (abnormal) operating conditions like for example supply voltage at 30 Vdc, short circuit on the outputs and on the inputs terminals.

The power dissipated P_d inside the enclosure for analog signal isolators is: $P_d = \text{Current Consumption (A)} * \text{Supply Voltage (V)} - \text{Power Dissipated into the input/output loads}$
 Analog signal isolators have higher dissipation than digital signal isolators. In analog signal isolators each transmitter requires and dissipates $15\text{ V} * 0.02\text{ A} = 0.3\text{ W}$. Usually the loads outside the isolator dissipate 1/3 of the total power used. Isolators are not running at the maximum current all at the same time, the average power consumption of a multitude of isolators can be considered to be only 70 % of the value obtained from the section "Technical Data". Considering the 1/3 load power and the 70 % above discussed, the power effectively dissipated internally by the isolators can therefore become 1/2 of the actual power delivered by the power supply. Digital barriers dissipate all the supply power inside the enclosure consequently the total power dissipation into a cabinet, with mixed analog and digital barriers, is determined by the number of channels more than by the number of isolator enclosures. The following tables give advises for the DIN rail orientation (vertical or horizontal) of the barriers mounting, D1180D (double channel), installed on DIN rail or custom board assembly.

A) Cabinet with Natural Ventilation

Maximum recommended ambient temperature in °C depending on barrier type and installation method:

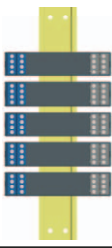
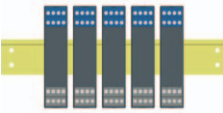
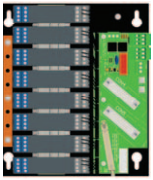
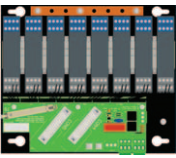
Type of Isolator	Single unit Installation	Installation of Multiple units with DIN-rail Bus		Installation on Custom Boards	
	Any orientation	Vertical	Horizontal	Vertical	Horizontal
					
D1180D	60°C	Not recommended ⁽¹⁾	30°C	30°C	35°C

⁽¹⁾ Installation is not recommended since it would significantly shorten the units life and increase the probability of failures.

B) Cabinet with Forced Ventilation

Maximum recommended ambient temperature in °C depending on barrier type and installation method:

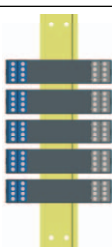
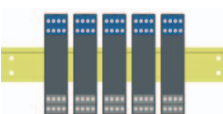
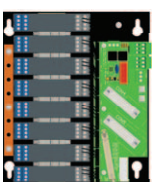
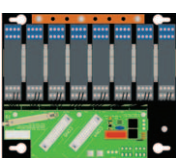
Type of Isolator	Single unit Installation	Installation of Multiple units with DIN-rail Bus		Installation on Custom Boards	
	Any orientation	Vertical	Horizontal	Vertical	Horizontal
					
D1180D	60°C	40°C	45°C	45°C	50°C

