



INSTRUCTION MANUAL

Load Cell/Strain Gauge Bridge Isolating Converter Din-Rail Model D1064S

Characteristics

General Description: The single channel DIN Rail Load Cell/Strain Gauge Bridge Isolating Converter D1064S acts as a galvanically isolated interface installed between a PLC/DCS in Safe Area and a load cell (or group of load cells) in Hazardous Area. Up to four 350 Ω load cells, or five 450 Ω load cells, or ten 1000 Ω load cells can be connected in parallel. It provides a fully floating power supply voltage with remote sensing capabilities to load cells located in Hazardous Area and converts the mV signal from the load cell into a 0/4-20 mA or 0/1-5 V or 0/2-10 V signal according to user desired range. Output circuit provides both current source and sink capabilities. Modbus output is also provided to interface PLC/DCS using digital communication.

Automatic Calibration: Automatic calibration can be accomplished in the field without disconnecting the unit.

Function: 1 channel I.S. input from strain gauge signals, provides 3 port isolation (input/output/supply) and current (source or sink mode) or voltage output signal. Modbus output is also provided to interface digital device.

Signalling LED: Power supply indication (green).

Configurability: Totally software configurable, no jumpers or switches, input calibration, mA or V output signal by GM Pocket Portable Configurator PPC1090, powered by the unit or configured by PC via RS-232 serial line with PPC1092 Adapter and SWC1090 Configurator software. A 16 characters tag can be inserted using the configuration software.

EMC: Fully compliant with CE marking applicable requirements.

Technical Data

Supply: 24 Vdc nom (20 to 30 Vdc) reverse polarity protected, ripple within voltage limits ≤ 5 Vpp.

Current consumption @ 24 V: 70 mA with four 350 Ω load cells connected and with 20 mA output typical.

Power dissipation: 1.4 W with 24 V supply voltage, four 350 Ω load cells connected and 20 mA output typical.

Max. power consumption: at 30 V supply voltage, short circuit input, overload condition and PPC1090 connected, 2.2 W.

Isolation (Test Voltage): I.S. In/Out 1.5 KV; I.S. In/Modbus Out 1.5 KV; I.S. In/Supply 1.5 KV; Out/Supply 500 V; Modbus Out/Supply 500 V; Out/Modbus Out 500 V.

Input: up to four 350 Ω load cells (parallel connection).
up to five 450 Ω load cells (parallel connection).
up to ten 1000 Ω load cells (parallel connection).

A/D Conversion time: 100 ms.

Bridge supply voltage: 4.2 V nominal.

Bridge output signal: 1 to 4 mV/V.

Line resistance compensation: ≤ 10 Ω .

Output: 0/4 to 20 mA, on max. 600 Ω load in source mode; V min. 5 V at 0 Ω load V max. 30 V in sink mode, current limited at 22 mA or 0/1 to 5 V or 0/2 to 10 V signal, limited at 11 V.

Resolution: 1 μ A current output or 1 mV voltage output.

Response time: ≤ 50 ms (10 to 90 % step change).

Output ripple: ≤ 20 mVrms on 250 Ω load.

Modbus Output: Modbus RTU protocol up to 115.200 baud.

Performance: Ref. Conditions 24 V supply, 250 Ω load, 23 ± 1 $^{\circ}$ C ambient temperature.

Input:

Accuracy after autocalibration: $\leq \pm 0.05$ % of full scale.

Linearity accuracy: $\leq \pm 0.02$ % of full scale of input range.

Temperature influence: $\leq \pm 0.002$ % of full scale of input range for a 1 $^{\circ}$ C change.

Supply voltage influence: $\leq \pm 0.002$ % of full scale of input range for a min to max supply voltage change.

Analog Output:

Calibration accuracy: $\leq \pm 0.05$ % of full scale.

Linearity error: $\leq \pm 0.05$ % of full scale.

Supply voltage influence: $\leq \pm 0.02$ % of full scale for a min to max supply change.

Load influence: $\leq \pm 0.02$ % of full scale for a 0 to 100 % load resistance change.

Temperature influence: $\leq \pm 0.01$ % on zero and span for a 1 $^{\circ}$ C change.

Compatibility:

 CE mark compliant, conforms to 94/9/EC Atex Directive and to 2004/108/CE EMC Directive.

Environmental conditions: Operating: temperature limits -20 to $+60$ $^{\circ}$ C, relative humidity max 90 % non condensing, up to 35 $^{\circ}$ C.

Storage: temperature limits -45 to $+80$ $^{\circ}$ C.

Safety Description:



II (1) G [Ex ia Ga] IIC, II (1) D [Ex ia Da] IIIC, I (M1) [Ex ia Ma] I, II 3G Ex nA II T4, [Ex ia Ga] IIC, [Ex ia Da] IIIC, [Ex ia Ma] I associated electrical apparatus.

$U_0/V_{oc} = 5.9$ V, $I_0/I_{sc} = 196$ mA, $P_o/P_i = 576$ mW at terminals 9-10-11-12-13-14.

$U_m = 250$ Vrms, -20 $^{\circ}$ C $\leq T_a \leq 60$ $^{\circ}$ C.

Approvals: DMT 01 ATEX E 042 X conforms to EN60079-0, EN60079-11, EN60079-26, EN61241-0, EN61241-11,

IECEx BVS 07.0027X conforms to IEC60079-0, IEC60079-11, IEC60079-26, IEC61241-0, IEC61241-11, IMQ 09 ATEX 013 X conforms to EN60079-0, EN60079-15,

FM & FM-C No. 3024643, 3029921C, conforms to Class 3600, 3610, 3611, 3810 and C22.2 No.142, C22.2 No.157, C22.2 No.213, E60079-0, E60079-11, E60079-15.

Mounting: T35 DIN Rail according to EN50022.

Weight: about 155 g.

Connection: by polarized plug-in disconnect screw terminal blocks to accommodate terminations up to 2.5 mm².

Location: Safe Area/Non Hazardous Locations or Zone 2, Group IIC T4, Class I, Division 2, Groups A, B, C, D Temperature Code T4 and Class I, Zone 2, Group IIC, IIB, IIA T4 installation.

Protection class: IP 20.

Dimensions: Width 22.5 mm, Depth 99 mm, Height 114.5 mm.

Ordering information

Model:	D1064S	
Power Bus enclosure		/B

Operating parameters are programmable by the GM Pocket Portable Configurator PPC1090 or via RS-232 serial line with PPC1092 Adapter and SWC1090 Configurator software. If the parameters are provided with the purchasing order the unit will be configured accordingly, otherwise the unit will be supplied with default parameters.

Front Panel and Features

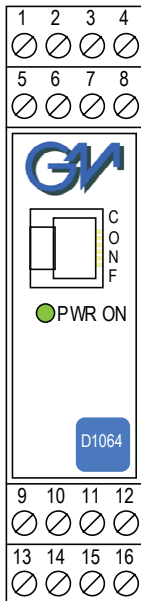

- Input from Zone 0 (Zone 20), Division 1, installation in Zone 2, Division 2.
- Strain Gauge Bridge Isolated Converter.
- Up to four 350 Ω load cells in parallel or up to five 450 Ω load cells in parallel or up to ten 1000 Ω load cells in parallel.
- 0/4-20 mA, 0/1-5 V, 0/2-10 V Output Signal.
- Modbus Output
- Field Automatic Calibration.
- Three port isolation, Input/Output/Supply.
- EMC Compatibility to EN61000-6-2, EN61000-6-4.
- Fully programmable operating parameters.
- ATEX, IECEx, FM & FM-C Certifications.
- High Reliability, SMD components.
- Simplified installation using standard DIN Rail and plug-in terminal blocks.
- 250 Vrms (Um) max. voltage allowed to the instruments associated with the barrier.

Terminal block connections

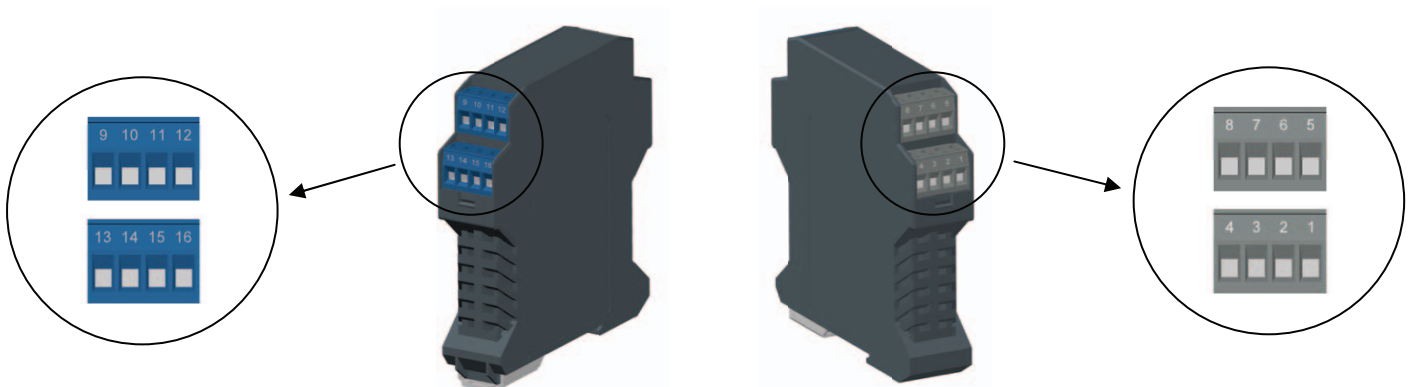

HAZARDOUS AREA

9	Input Ch 1 +EXC (Load cell)
10	Input Ch 1 +Sense (Load cell)
11	Input Ch 1 -Sense (Load cell)
12	Input Ch 1 -EXC (Load cell)
13	Input Ch 1 +IN (Load cell)
14	Input Ch 1 -IN (Load cell)
15	Not used
16	Not used

SAFE AREA

1	Output Ch 1 A- for MODBUS IN/OUT RS485
2	Output Ch 1 B+ for MODBUS IN/OUT RS485
3	+ Power Supply 24 Vdc
4	- Power Supply 24 Vdc
5	+ Output Ch 1 for Current Source mode
6	- Output Ch 1 for Current Source mode or + Output Ch 1 for Current Sink mode
7	+ Output Ch 1 for Voltage Source mode
8	- Output Ch 1 for Current Sink mode or - Output Ch 1 for Voltage Source mode

Parameters Table

In the system safety analysis, always check the Hazardous Area/Hazardous Locations devices to conform with the related system documentation, if the device is Intrinsically Safe check its suitability for the Hazardous Area/Hazardous Locations and gas group encountered and that its maximum allowable voltage, current, power (U_i/V_{max} , I_i/I_{max} , P_i/P_i) are not exceeded by the safety parameters (U_o/V_{oc} , I_o/I_{sc} , P_o/P_o) of the D1064 Associated Apparatus connected to it. Also consider the maximum operating temperature of the field device, check that added connecting cable and field device capacitance and inductance do not exceed the limits (C_o/C_a , L_o/L_a , L_o/R_o) given in the Associated Apparatus parameters for the effective gas group. See parameters on enclosure side and the ones indicated in the table below:

D1064 Terminals		D1064 Associated Apparatus Parameters	Must be	Hazardous Area/ Hazardous Locations Device Parameters
Ch1	9 - 10 - 11 - 12 - 13 - 14	$U_o / V_{oc} = 5.9 \text{ V}$	\leq	U_i / V_{max}
Ch1	9 - 10 - 11 - 12 - 13 - 14	$I_o / I_{sc} = 196 \text{ mA}$	\leq	I_i / I_{max}
Ch1	9 - 10 - 11 - 12 - 13 - 14	$P_o / P_o = 576 \text{ mW}$	\leq	P_i / P_i
D1064 Terminals		D1064 Associated Apparatus Parameters	Must be	Hazardous Area/ Hazardous Locations Device + Cable Parameters
Ch1	9 - 10 - 11 - 12 - 13 - 14	$C_o / C_a = 39 \mu\text{F}$ (IIC-A, B) $C_o / C_a = 996 \mu\text{F}$ (IIB-C) $C_o / C_a = 996 \mu\text{F}$ (IIA-D)	\geq	$C_i / C_i \text{ device} + C \text{ cable}$
Ch1	9 - 10 - 11 - 12 - 13 - 14	$L_o / L_a = 0.93 \text{ mH}$ (IIC-A, B) $L_o / L_a = 3.71 \text{ mH}$ (IIB-C) $L_o / L_a = 7.42 \text{ mH}$ (IIA-D)	\geq	$L_i / L_i \text{ device} + L \text{ cable}$
Ch1	9 - 10 - 11 - 12 - 13 - 14	$L_o / R_o = \text{N/A}$ (IIC-A, B) $L_o / R_o = 247 \mu\text{H}/\Omega$ (IIB-C) $L_o / R_o = 494.1 \mu\text{H}/\Omega$ (IIA-D)	\geq	$L_i / R_i \text{ device and}$ $L \text{ cable} / R \text{ cable}$

NOTE for USA and Canada:
 IIC equal to Gas Groups A, B, C, D, E, F and G
 IIB equal to Gas Groups C, D, E, F and G
 IIA equal to Gas Groups D, E, F and G

For installations in which both the C_i and L_i of the Intrinsically Safe apparatus exceed 1 % of the C_o and L_o parameters of the Associated Apparatus (excluding the cable), then 50 % of C_o and L_o parameters are applicable and shall not be exceeded (50 % of the C_o and L_o become the limits which must include the cable such that $C_i \text{ device} + C \text{ cable} \leq 50 \% \text{ of } C_o$ and $L_i \text{ device} + L \text{ cable} \leq 50 \% \text{ of } L_o$).

If the cable parameters are unknown, the following value may be used: Capacitance 60pF per foot (180pF per meter), Inductance 0.20μH per foot (0.60μH per meter).

The Intrinsic Safety Entity Concept allows the interconnection of Intrinsically Safe devices approved with entity parameters not specifically examined in combination as a system when the above conditions are respected.

For Division 1 and Zone 0 installations, the configuration of Intrinsically Safe Equipment must be FM approved under Entity Concept (or third party approved);

for Division 2 installations, the configuration of Intrinsically Safe Equipment must be FM approved under non-incendive field wiring or Entity Concept (or third party approved).

Function Diagram

HAZARDOUS AREA ZONE 0 (ZONE 20) GROUP IIC,
HAZARDOUS LOCATIONS CLASS I, DIVISION 1, GROUPS A, B, C, D,
CLASS II, DIVISION 1, GROUPS E, F, G, CLASS III, DIVISION 1,
CLASS I, ZONE 0, GROUP IIC

SAFE AREA, ZONE 2 GROUP IIC T4,
NON HAZARDOUS LOCATIONS, CLASS I, DIVISION 2,
GROUPS A, B, C, D T-Code T4, CLASS I, ZONE 2, GROUP IIC T4

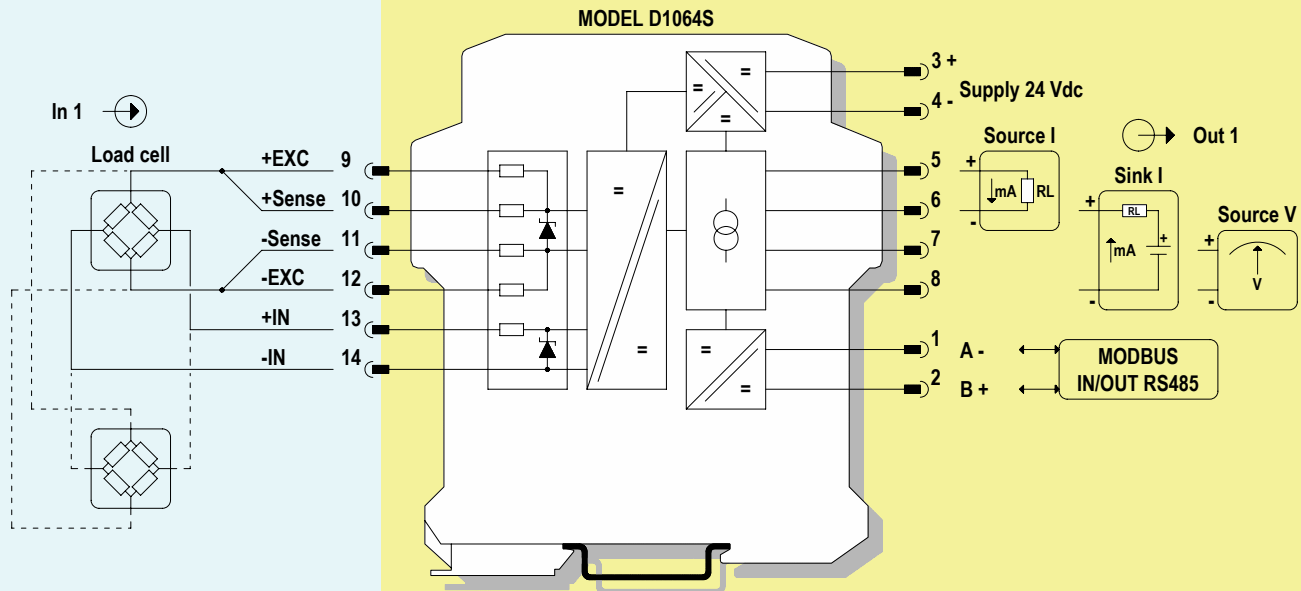

Up to 4 load cells 350 Ω in parallel
Up to 5 load cells 450 Ω in parallel
Up to 10 load cells 1000 Ω in parallel

Warning

D1064 is an isolated Intrinsically Safe Associated Apparatus installed into standard EN50022 T35 DIN Rail located in Safe Area / Non Hazardous Locations or Zone 2, Group IIC, Temperature Classification T4, Class I, Division 2, Groups A, B, C, D, Temperature Code T4 and Class I, Zone 2, Group IIC, IIB, IIA Temperature Code T4 Hazardous Area/Hazardous Locations (according to EN/IEC60079-15, FM Class No. 3611, CSA-C22.2 No. 213-M1987, CSA-E60079-15) within the specified operating temperature limits Tamb -20 to +60 °C, and connected to equipment with a maximum limit for AC power supply Um of 250 Vrms.

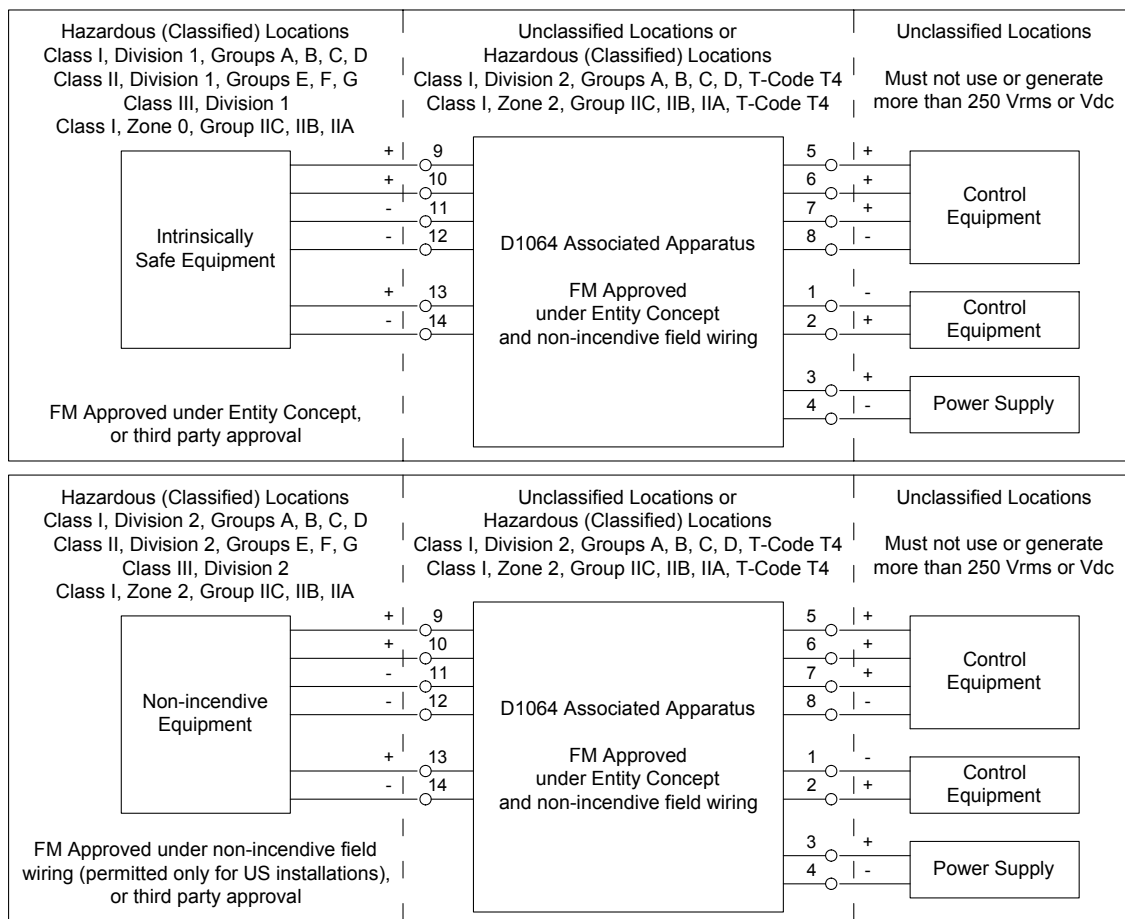

Non-incendive field wiring is not recognized by the Canadian Electrical Code, installation is permitted in the US only.

For installation of the unit in a Class I, Division 2 or Class I, Zone 2 location, the wiring between the control equipment and the D1064 associated apparatus shall be accomplished via conduit connections or another acceptable Division 2, Zone 2 wiring method according to the NEC and the CEC.

Not to be connected to control equipment that uses or generates more than 250 Vrms or Vdc with respect to earth ground.

D1064 must be installed, operated and maintained only by qualified personnel, in accordance to the relevant national/international installation standards

(e.g. IEC/EN60079-14 Electrical apparatus for explosive gas atmospheres - Part 14: Electrical installations in hazardous areas (other than mines), BS 5345 Pt4, VDE 165, ANSI/ISA RP12.06.01 Installation of Intrinsically Safe System for Hazardous (Classified) Locations, National Electrical Code NEC ANSI/NFPA 70 Section 504 and 505, Canadian Electrical Code CEC) following the established installation rules, particular care shall be given to segregation and clear identification of I.S. conductors from non I.S. ones. De-energize power source (turn off power supply voltage) before plug or unplug the terminal blocks when installed in Hazardous Area/Hazardous Locations or unless area is known to be nonhazardous.

Warning: substitution of components may impair Intrinsic Safety and suitability for Division 2, Zone 2.

Explosion Hazard: to prevent ignition of flammable or combustible atmospheres, disconnect power before servicing or unless area is known to be nonhazardous.

Failure to properly installation or use of the equipment may risk to damage the unit or severe personal injury.

The unit cannot be repaired by the end user and must be returned to the manufacturer or his authorized representative. Any unauthorized modification must be avoided.

Operation

The Load Cell/Strain Gauge Bridge Isolating Converter D1064S acts as a galvanic isolated interface installed between a PLC/DCS in Safe Area/Non Hazardous Locations and a load cell (or group of load cells) in Hazardous Area/Hazardous Locations. Up to four 350 Ω load cells, or five 450 Ω load cells, or ten 1000 Ω load cells can be connected in parallel.

It provides a fully floating power supply voltage with remote sensing capabilities to load cell located in Hazardous Area/Hazardous Locations and converts the mV signal from load cell into a 0/4-20 mA or 0/1-5 V or 0/2-10 V signal according to user desired range.

Remote sensing wires (terminals "10" +Sense and "11" -Sense) must be always connected to force lines (terminals "9" +Exc and "12" -Exc) for proper operation of the unit, in case of 4 wires cell connect the sensing lines near to the cell connections to minimize the power supply voltage compensation error.

Output circuit provides both current source and sink capabilities. Modbus output is also provided to interface PLC/DCS using digital communication.

Presence of supply power is displayed by a green signaling LED.

The isolator provides an automatic calibration function that greatly simplifies the range setup; the automatic calibration requires only a calibration weight and can be executed in field using the hand-held configurator, without disconnecting the unit (check that area is known to be nonhazardous before proceeding).

The hand-held configurator allows also online monitoring of the isolator operation and measures.

Note that complete system calibration is necessary to obtain the correct value reading. Please follow the instructions manual to setup the system.

The unit is not certified for trading applications, is responsibility of the user to obtain specific approvals if the system is subject to specific regulatory requirements regarding trading (e.g. EN45501 requirements in Europe).

Automatic Calibration

The D1064 automatic calibration operates correcting the system zero and range errors, it will be performed when the system operating placing the calibration weight on the scale platform. It is operated as follows: Set the ACAL - C REF value: the weight value that will be used for calibration (must be equal to or lower than ACAL - C RNG) Set the ACAL - C RNG value: the weighing range of the system (will define the analog outputs full scale) Remove any weight on the platform (gross weight equal to zero); wait until the system is stable than acquire the weight ZERO Place the reference weight on the platform (the same value entered as ACAL - C REF); wait until the system is stable than acquire the weight REF Remove the reference weight: the system is calibrated. The two analog outputs are scaled for downscale = ZERO weight, upscale = RANGE weight without any further action. The Modbus reading is scaled with the same divisions as entered for the value ACAL - C REF.

Installation

D1064 is a load cell/strain gauge bridge converter housed in a plastic enclosure suitable for installation on T35 DIN Rail according to EN50022. D1064 unit can be mounted with any orientation over the entire ambient temperature range, see section "Installation in Cabinet" and "Installation of Electronic Equipments in Cabinet" Instruction Manual D1000 series for detailed instructions. D1064 signal converter operates at low level measuring signals, for best performance, install it far from heat sources (heat dissipating equipment) and wide temperature excursions, in example at the bottom of a cabinet with heat dissipating equipment, if any, at the top. Electrical connection of conductors up to 2.5 mm² are accommodated by polarized plug-in removable screw terminal blocks which can be plugged in/out into a powered unit without suffering or causing any damage (**for Zone 2 or Division 2 installations check the area to be nonhazardous before servicing**). The wiring cables have to be proportionate in base to the current and the length of the cable. On the section "Function Diagram" and enclosure side a block diagram identifies all connections. Identify the function and location of each connection terminal using the wiring diagram on the corresponding section, as an example: Connect 24 Vdc power supply positive at terminal "3" and negative at terminal "4". Connect current source mode positive output at terminal "5" and negative output at "6" or current sink mode positive output at terminal "6" and negative output at terminal "8" (output can be used only one type at a time, not contemporary). Connect voltage output positive at terminal "7" and negative output at terminal "8" (voltage output can be used simultaneously with current output, providing that the two systems connected to are isolated). Connect serial line Modbus output at terminal "1" and at terminal "2". Connect strain gauge bridge voltage supply at terminal "9" positive and terminal "12" negative. Connect strain gauge bridge voltage sensing supply at terminal "10" positive and terminal "11" negative. If strain gauge bridge has no internal voltage sensing capability always connect terminal "10" to terminal "9" and terminal "11" to terminal "12"; for better performance connect the wire at the end of the line near the load cells. Connect strain gauge bridge output signal at terminal "13" positive and terminal "14" negative.

Intrinsically Safe conductors must be identified and segregated from non I.S. and wired in accordance to the relevant national/international installation standards (e.g. EN/IEC60079-14 Electrical apparatus for explosive gas atmospheres - Part 14: Electrical installations in hazardous areas (other than mines), BS 5345 Pt4, VDE 165, ANSI/ISA RP12.06.01 Installation of Intrinsically Safe System for Hazardous (Classified) Locations, National Electrical Code NEC ANSI/NFPA 70 Section 504 and 505, Canadian Electrical Code CEC), make sure that conductors are well isolated from each other and do not produce any unintentional connection. The enclosure provides, according to EN60529, an IP20 minimum degree of mechanical protection (or similar to NEMA Standard 250 type 1) for indoor installation, outdoor installation requires an additional enclosure with higher degree of protection (i.e. IP54 to IP65 or NEMA type 12-13) consistent with the effective operating environment of the specific installation. Units must be protected against dirt, dust, extreme mechanical (e.g. vibration, impact and shock) and thermal stress, and casual contacts. If enclosure needs to be cleaned use only a cloth lightly moistened by a mixture of detergent in water. **Electrostatic Hazard: to avoid electrostatic hazard, the enclosure of D1064 must be cleaned only with a damp or antistatic cloth.** Any penetration of cleaning liquid must be avoided to prevent damage to the unit. Any unauthorized card modification must be avoided. According to EN61010, D1064 must be connected to SELV or SELV-E supplies.

Start-up

Before powering the unit check that all wires are properly connected, particularly supply conductors and their polarity, input and output wires, also check that Intrinsically Safe conductors and cable trays are segregated (no direct contacts with other non I.S. conductors) and identified either by color coding, preferably blue, or by marking. Check conductors for exposed wires that could touch each other causing dangerous unwanted shorts. Turn on power, the "power on" green led must be lit, output must be in accordance with the corresponding input signal value. If possible change the load cell condition and check the corresponding Safe Area output.



Installation in Cabinet

Power Dissipation of D1064 Isolators

Section "Technical Data" of D1064 isolator specifies the current consumption (maximum current from the nominal power supply, typical 24 Vdc, in normal operation); this data serves to dimension the current rating of the power supply unit. Section "Technical Data" indicates also the maximum power consumption (maximum power required from the power supply in the worst (abnormal) operating conditions like for example supply voltage at 30 Vdc, short circuit on the outputs and on the inputs terminals. The power dissipated **P_d** inside the enclosure for analog signal isolators is: **P_d = Current Consumption (A) * Supply Voltage (V) - Power Dissipated into the input/output loads** Analog signal isolators have higher dissipation than digital signal isolators. In analog signal isolators each transmitter requires and dissipates 15 V * 0.02 A = 0.3 W. Usually the loads outside the isolator dissipate 1/3 of the total power used. Isolators are not running at the maximum current all at the same time, the average power consumption of a multitude of isolators can be considered to be only 70 % of the value obtained from the section "Technical Data". Considering the 1/3 load power and the 70 % above discussed, the power effectively dissipated internally by the isolators can therefore become 1/2 of the actual power delivered by the power supply. Digital barriers dissipate all the supply power inside the enclosure consequently the total power dissipation into a cabinet, with mixed analog and digital barriers, is determined by the number of channels more than by the number of isolator enclosures. The following tables give advises for the DIN rail orientation (vertical or horizontal) of the barriers mounting, D1064S (single channel) isolators, installed on DIN rail, bus or custom board assembly.

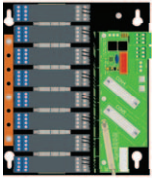
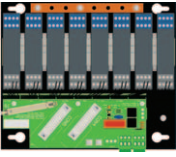

A) Cabinet with Natural Ventilation

Maximum recommended ambient temperature in °C depending on barrier type and installation method:

Type of Isolator	Single unit Installation	Installation of Multiple units with DIN-rail Bus		Installation on Custom Boards	
	Any orientation	Vertical	Horizontal	Vertical	Horizontal
					
D1064S	60°C	30°C	35°C	35°C	40°C

B) Cabinet with Forced Ventilation

Maximum recommended ambient temperature in °C depending on barrier type and installation method:

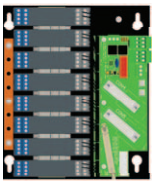
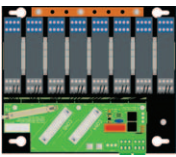
Type of Isolator	Single unit Installation	Installation of Multiple units with DIN-rail Bus		Installation on Custom Boards	
	Any orientation	Vertical	Horizontal	Vertical	Horizontal
					
D1064S	60°C	40°C	45°C	45°C	50°C

Modbus Communication Line

The D1064 provides a Modbus RTU communication over a RS-485 pair. The RS-485 communication line must be connected according to the RS-485 specifications: the cable must have a 100 Ω nominal impedance and must be terminated at both ends with a 100 Ω resistor; care must be exercised for the proper polarity of all units connected to the bus, additionally all equipments must operate at the same baud rate and with the same parity (if used). The line termination resistors must be installed externally.

Modbus Communication Protocol

The Modbus protocol is widely used to exchange data between master and slave units in industrial environments; the advantage is that common physical supports such as RS-485 or RS-232 communication lines can be used; additionally the protocol's simplicity and wide application permits its use with many computers or PLC and a variety of application programs are available. Line drivers ranging up to a speed of 115200 bit/s allow fast and efficient data transfer. The format used by the D1064 isolator is the RTU (Remote Terminal Unit) format, exchanging data using 8 bit bytes. The advantage of this mode is that its density allows high data throughput for the baud rate used. The message is transmitted in a continuous stream, an interval of 1.5 character defines the end of a frame. A typical Modbus frame is constituted by the following fields:

Address	Function	Data	CRC Check
8 bit slave address	8 bit function code	N x 8 bit data field	16 bit crc field

The address field of a message frame contains a eight bits slave addresses in the range 0 to 247 decimal. The individual slave is assigned addresses in the range of 1 to 247. A master addresses a slave by placing the slave address in the address field of the message. When the slave sends its response, it places its own address in this address field of the response frame. Address 0 is used for the broadcast address, which is recognized by all slaves. The function code field of a message frame contains a byte defining the function code. When a message is sent from a master to a slave, the function code tells the slave the kind of action to perform. When the slave responds to the master, it uses the function code field to indicate either a normal (error-free) response or that some kind of error occurred (called exception response); in addition the slave places a unique code into the data field of the response message: this tells the master what kind of error occurred. The data field has different size and format as a function of the command involved, detailed data formats for master/slave and slave/master messages are defined for every type of command. If no error occurs, the data field of a response from a slave to a master contains the data requested. If an error occurs, the field contains an exception code that the master application can use to determine the type of error. The error checking field contains a 16 bit value. The error check value is the result of a Cyclical Redundancy Check calculation performed on the message contents. The CRC field is appended to the message as the last field in the message. The receiving device recalculates a CRC during receipt of the message, and compares the calculated value to the actual value it received in the CRC field. If the two values are not equal, an error results.

Supported commands

Command codes supported by the D1064 are a subset of the Modbus commands, other commands will generate an exception response:

Function Code	Function Name	Notes
03 (0x03)	Read Holding Registers	reads a stream of words from the D1064 memory
04 (0x04)	Read Input Registers	reads a stream of words from the D1064 memory
06 (0x06)	Preset Single Register	writes a word into the D1064 memory
16 (0x10)	Preset Multiple Registers	writes a stream of words from the D1064 memory

Commands 3, 4 – Read Holding/Input Registers

This function code is used to read the contents of a contiguous block of registers. The starting address and the number of registers are addressed starting from zero. The register data in the response message are packed as two bytes per register, for each register, the first byte contains the high order bits and the second contains the low order bits. The format of the request is:

Name	Size	Value
Function Code	1 byte	0x03 or 0x04
Starting Address	2 bytes	see word address section
Number of Registers	2 bytes	see word address section

The format of the response is:

Name	Size	Value
Function Code	1 byte	0x03 or 0x04
Byte count	1 byte	2 x number of registers
Data	2 x N bytes	2 bytes for every register

Command 6 – Preset Single Register

This function code is used to write the contents of a register to the D1064. Addresses start from zero. The register data must be packed as two bytes, the first byte contains the high order bits and the second contains the low order bits. The normal response is an echo of the request. The format of the request is:

Name	Size	Value
Function Code	1 byte	0x06
Register Address	2 bytes	see word address section
Register value	2 bytes	see word address section

The format of the response is:

Name	Size	Value
Function Code	1 byte	0x06
Register Address	2 bytes	Copy of request
Register value	2 bytes	Copy of request

Command 16 – Preset Multiple Registers

This function code is used to write the contents of a contiguous block of registers into the D1064. The starting address and the number of registers are addressed starting from zero. Register data are packed as two bytes for each register, the first byte contains the high order bits and the second contains the low order bits. The format of the request is:

Name	Size	Value
Function Code	1 byte	0x06
Starting Address	2 bytes	see word address section
Number of Registers	2 bytes	see word address section
Data to be written	2 x N bytes	2 bytes for every register

The format of the response is:

Name	Size	Value
Function Code	1 byte	0x10
Starting Address	2 bytes	Copy of request
Number of Registers	2 bytes	Copy of request

Errors – Exception Responses

If the D1064 does not receive the request due to a communication error, or detects a wrong CRC value, no response is returned. The master program should eventually process a timeout condition for the request. If the D1064 receives the request without a communication error, but cannot handle it (e.g. if the request is to read a non-existing register), it will return an exception response informing the master of the nature of the error. The format of the exception response is:

Name	Size	Value
Function Code	1 byte	0x8x
Exception Code	1 byte	0x01, 0x02, 0x03

In a normal response, the D1064 echoes the requested function code in the function code field of the response. All function codes have the most-significant bit (MSB) equal to 0 (values below 0x80). In an exception response, the D1064 sets the MSB of the function code: this makes the function code value in an exception response exactly 0x80 higher than the value of a normal response. In a normal response, the D1064 can return data in the data field, in an exception response, the D1064 returns an exception code in the data field, this defines the condition that caused the exception. Handled exceptions are:

Code	Name	Notes
01	Illegal Function	function code received in the query is not executable by the D1064 (code different from 03, 04, 06, 16)
02	Illegal Data Address	data address received in the query is not an allowable address, more specifically the combination of starting and data length is invalid
03	Illegal Data Value	a value contained in the query data field is not an allowable value. This indicates a fault in the structure of the remainder of a complex request

Register Addresses

Register addresses used by Modbus are unsigned integer indices starting at zero, from 0 to 65535. The value is an HEX word that can be interpreted as a unsigned or signed integer (unsigned from 0 to 65535, signed in offset binary form -32768 to +32767). Addresses used by the D1064 are defined in the following tables.

Data Registers

Data registers contain information on input measuring circuits, they are allocated as words at the following addresses:

Address	To	Description	Type	Note
0000	0000	Weight Reading	Signed Integer	Read only, resolution depending upon ACAL - C RNG
0001	01FF	Reserved	Unsigned Integer	Read only, return 0000

Configuration Registers

Configuration registers contain information on isolator configuration, they are allocated at the following addresses:

Address	To	Description	Type	Note
0200	02FF	Reserved	Unsigned Integer	Read only, return 0000

System Registers

System registers contain information on isolator system registers, they are allocated at the following addresses:

Address	To	Description	Type	Note
0400	041F	Reserved	Unsigned Integer	Read only, return 0000

The Pocket Portable Configurator type PPC1090 is suitable to configure the "smart" barrier of D1000 series. The PPC1090 unit is not ATEX, UL or FM approved and is only to be used in Safe Area/Non Hazardous Locations and prior to installation of the isolator and prior to connection of any I.S. wiring. Do not use PPC1090 configurator in Hazardous Area/Hazardous Locations. The PPC1090 configurator is powered by the unit (no battery power) when the telephone jack is plugged into the barrier (RJ12 6 poles connector type with 1:1 connection). It has a 5 digit display, 4 leds and four push buttons with a menu driven configuration software and can be used in Safe Area/Non Hazardous Locations without any certification because it plugs into the non intrinsically safe portion of circuit.

PPC1090 Configuration

The configuration procedure follows a unit specific menu. The display shows the actual menu item, the led shows the channel configured and the push button actuates as "Enter", "Select", "Down" and "Up" key. The "Enter" key is pressed to confirm the menu item, the "Select" key is pressed to scroll the menu item, the "Down" and "Up" keys are pressed to decrement or increment the numeric value of menu item. The "Up" key is also pressed to decrement the menu level. When the PPC1090 is plugged into the unit, the display shows the barrier model (first level menu). Then press the "Enter" key to the second level menu and the "Select" key to scroll the menu voice. When the selected menu item is displayed press the "Enter" key to confirm the choice. Follow this procedure for every voice of the menu. When a numeric menu item is to be changed, press the "Select" key to highlight the character and then the "Up" and "Down" keys to select the number; confirm the modification with the "Enter" key. To return to a higher level menu press the "Up" key.

D1064S Menu

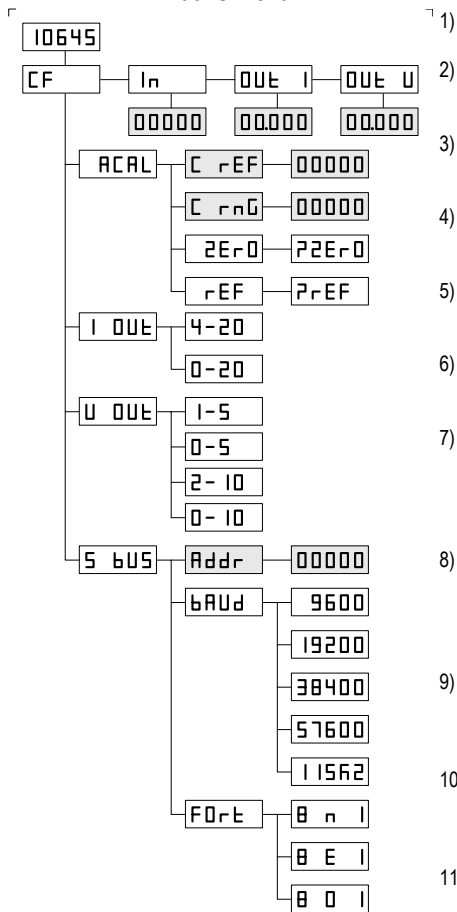

Menu item description

- 1) **D1064S** [1 Level Menu]
Displays Model D1064S. Press "Enter" key to second level menu.
- 2) **CF** [2 Level Menu]
Displays the parameters configuration menu. Press "Enter" key to configure the functional parameters, press the "Select" key to the next menu level item or "Up" key to return to first level.
- 3) **In** [2 Level Menu]
Displays the input variable monitoring. Press "Enter" to display the current input value reading, press the "Select" key to the next menu level item or "Up" key to return to first level.
- 4) **Out I** [2 Level Menu]
Displays the current analog output variable monitoring. Press "Enter" to display the actual output value reading, press the "Select" key to the next menu level item or "Up" key to return to first level.
- 5) **Out U** [2 Level Menu]
Displays the voltage analog output variable monitoring. Press "Enter" to display the actual output value reading, press the "Select" key to the next menu level item or "Up" key to return to first level.
- 6) **ACAL** [3 Level Menu]
Displays the input calibration parameters. Press "Enter" immediately, before "ACAL" stops blinking, to configure the calibration parameters, press the "Select" key to the next menu level item or "Up" key to return to second level.
- 7) **C ref** [4 Level Menu]
Displays the reference weight at which the calibration is performed. Press "Enter" to set the value, press the "Select" key to the next menu level item or "Up" key to return to third level. If you pressed "Enter" key, you can set the reference weight value; press the "Select" key to highlight the character you want to change and then the "Up" and "Down" keys to select the number; confirm the modification with the "Enter" key. The value is settable from 0 to 30500 digit.
- 8) **C rng** [4 Level Menu]
Displays the upscale weight measured by the module. Press "Enter" to set the value, press the "Select" key to the next menu level item or "Up" key to return to third level. If you pressed "Enter" key, you can set the upscale weight value; press the "Select" key to highlight the character you want to change and then the "Up" and "Down" keys to select the number; confirm the modification with the "Enter" key. The value is settable from 0 to 30500 digit.
- 9) **Zero** [4 Level Menu]
Displays the zero reference calibration procedure. Press "Enter" to perform the zero calibration, press the "Select" key to the next menu level item or "Up" key to return to third level. If you pressed "Enter" key, the display is blinking waiting for confirmation of calibration procedure; confirm the procedure with the "Enter" key.
- 10) **Ref** [4 Level Menu]
Displays the reference calibration procedure. Press "Enter" to perform the reference weight calibration, press the "Select" key to the next menu level item or "Up" key to return to third level. If you pressed "Enter" key, the display is blinking waiting for confirmation of calibration procedure; confirm the procedure with the "Enter" key.
- 11) **I Out** [3 Level Menu]
Displays the current analog output type configuration. Press "Enter" to set the analog output range, press the "Select" key to the next menu level item or "Up" key to return to second level. If you pressed "Enter" key, you can choose between 2 different output ranges; press "Select" key to change the output range and then the "Enter" key to confirm the choice. The output types are:
4-20 4 to 20 mA current output 0-20 0 to 20 mA current output

- 12) **U Out** [3 Level Menu]
Displays the voltage analog output type configuration. Press "Enter" to set the analog output range, press the "Select" key to the next menu level item or "Up" key to return to second level. If you pressed "Enter" key, you can choose between 4 different output ranges; press "Select" key to change the output range and then the "Enter" key to confirm the choice. The output types are:
1-5 1 to 5 V voltage output 2-10 2 to 10 V voltage output
0-5 0 to 5 V voltage output 0-10 0 to 10 V voltage output
- 13) **S bus** [3 Level Menu]
Displays the Modbus communication parameters. Press "Enter" to configure the communication parameters, press the "Select" key to the next menu level item or "Up" key to return to second level.
- 14) **Addr** [4 Level Menu]
Displays the Modbus communication address. Press "Enter" to set the value, press the "Select" key to the next menu level item or "Up" key to return to third level. If you pressed "Enter" key, you can set the address value; press the "Select" key to highlight the character you want to change and then the "Up" and "Down" keys to select the number; confirm the modification with the "Enter" key. The value is settable from 1 to 255.
- 15) **Baud** [4 Level Menu]
Displays the Modbus communication baud rate configuration. Press "Enter" to set the baud rate value, press the "Select" key to the next menu level item or "Up" key to return to third level. If you pressed "Enter" key, you can choose between 5 different baud rate; press "Select" key to change the baud rate and then the "Enter" key to confirm the choice. The baud rate values are:
9600 9600 b/s rate 19200 19200 b/s rate
38400 38400 b/s rate 57600 57600 b/s rate
115k2 115200 b/s rate
- 16) **Fort** [4 Level Menu]
Displays the Modbus communication format configuration. Press "Enter" to set the communication format, press the "Select" key to the next menu level item or "Up" key to return to third level. If you pressed "Enter" key, you can choose between 3 different communication format; press "Select" key to change the format and then the "Enter" key to confirm the choice. The formats are:
8 N 1 8 bit data, no parity, 1 stop bit
8 E 1 8 bit data, even parity, 1 stop bit
8 O 1 8 bit data, odd parity, 1 stop bit

Software configuration procedure of the D1064S. SWC1090 Configurator is available for download at www.gmintsr.com.



Load from COM port:
reads parameters from the D1064S module.
Select button A and wait while parameters are retrieved from the D1064S.
Press button "OK" when done.

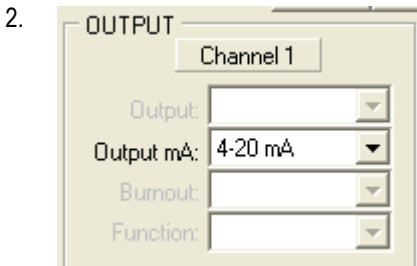

"Output mA:"
current analog output type configuration:
4-20 mA 4 to 20 mA current output
0-20 mA 0 to 20 mA current output

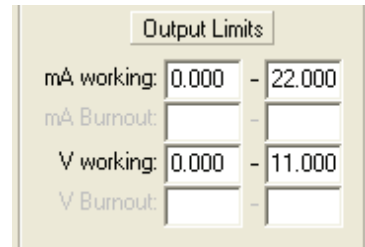

"Output Limits"
range limitations for current and voltage analog outputs:
"mA working": current analog output range in normal working condition.
"V working": voltage analog output range in normal working condition.

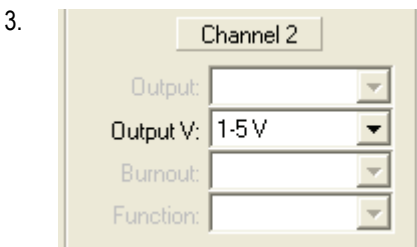

"Output V:"
voltage analog output type configuration.
1-5 V 1 to 5 V voltage output
0-5 V 0 to 20 V voltage output
2-10 V 2 to 10 V voltage output
0-10 V 0 to 10 V voltage output

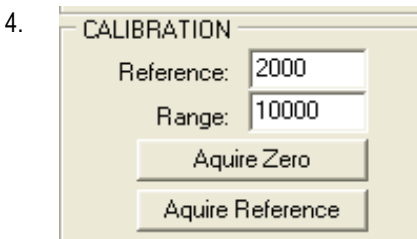

"Calibration" procedure for unit calibration.
"Range" maximum weight corresponding to full scale output.
Configurable from 0 to 30000 divisions. Higher values lead to greater resolutions.
"Reference" reference weight used for calibration.
Configurable from 0 to 30000 divisions. Must be lower than "Range".
Calculated as: $Reference[div] = (Range[div] \times Reference[u.m.]) / Range[u.m.]$

"Acquire Zero" press button to start the zero acquiring procedure.
A window is shown (fig. a): unload weighing platform and press "Acquire Zero".
"Acquire Reference" press button to start reference acquiring procedure.
A window is shown (fig. b): place reference weight on weighing platform.
Press "Acquire Reference" to proceed.

Calibration example:

- The application requires to measure weights up to 1000 Kgs (u.m. = Kgs)
The user decides to apply a reference weight of 200 Kgs.
- Solution 1) Using 10000 div as range, the reference must be set to 2000 div.
Output resolution is 0.1 Kgs/div (1000/10000).
 - Solution 2) Using 30000 div as range, the reference must be set to 6000 div.
Output resolution is 0.033. Kgs/div (1000/30000).

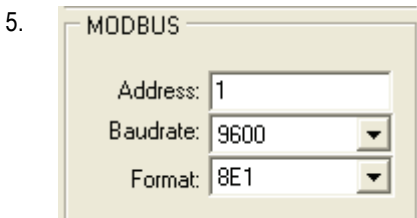
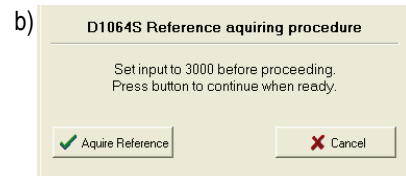
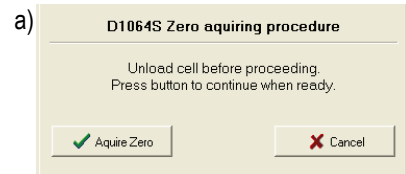

"Modbus" Modbus communication parameters.
"Address" Modbus communication address (from 1 to 255).
"Baudrate" Modbus communication baud rate. The values are:
9600 9600 b/s rate 19200 19200 b/s rate
38400 38400 b/s rate 57600 57600 b/s rate
115k2 115200 b/s rate
"Format" Modbus communication format:
8 N 1 8 bit data, no parity, 1 stop bit
8 E 1 8 bit data, even parity, 1 stop bit
8 O 1 8 bit data, odd parity, 1 stop bit

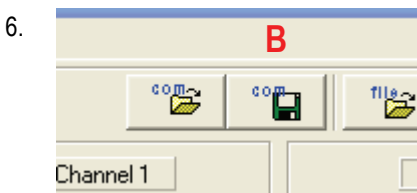

Save to COM port: writes current configuration to the D1064S module;
Select button B and wait while parameters are loaded into the D1064S.
Press button "OK" when done.