

## T.A. DI PROTEZIONE A BARRA 61x31 o CAVO Ø51 PASSANTE

### 61x31 Busbar or Ø51 Cable passing protection CTs

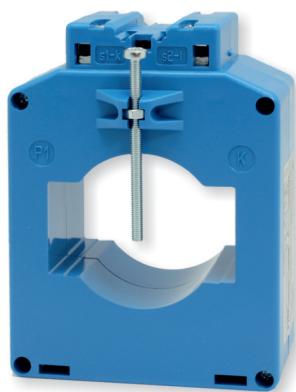

**EAC**



**Kz - Kazakhstan**

**INPUT:** 600A...  
2000A

**5A**

**OUTPUT:** 1A

#### DATI TECNICI - Technical data

custodia in materiale termoplastico autoestinguente	self extinguishing thermoplastic material	UL94-V0
frequenza funzionamento	operating frequency	50÷60 Hz
tensione di riferimento per l'isolamento	insulation reference voltage	0,72 kV
tensione di prova	test voltage	3 kV x 1'50 Hz
isolamento	insulation	classe E
grado di protezione	protection degree	IP 20
sovracorrente permanente	continuous overcurrent	1,2 In
corrente termica di breve durata nominale (I th)	rated short-time thermal current (I th)	60 In
corrente dinamica nominale (I dyn)	rated dynamic current (I dyn)	2,5 x I th
max. potenza dissipata (portata max.)	max. power dissipation (max range value)	≤10W
temperatura di funzionamento	operating temperature	-25 +50 °C
temperatura di magazzino	storage temperature	-40 +80 °C
costruzione a norme	manufactured according to	IEC/EN 61869-1 IEC/EN 61869-2
terminali secondari integrati	integrated secondary terminals	6mm <sup>2</sup>

#### TIPO - Type

#### DIMENSIONI - Dimensions

Rapporto Ratio	Codice - Code	
	VA	Cl. 5P5
600/5A	2	<b>TAT061600K05</b>
800/5A	3	<b>TAT061800K05</b>
1000/5A	4	<b>TAT0611K0K05</b>
1200/5A	5	<b>TAT0611K2K05</b>
1500/5A	6	<b>TAT0611K5K05</b>
2000/5A	8	<b>TAT0612K0K05</b>

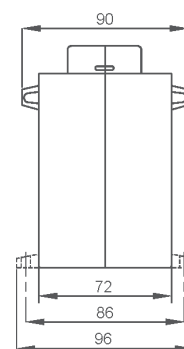
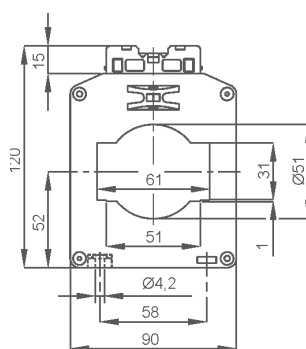

**Tipo con passaggio barra orizzontale**  
Codici ordinazione come in tabella

**Horizontal busbar passing type**  
same ordering codes as shown in table

**kg 0,70 ...1,40**

Sono disponibili i trasformatori con secondario 1A e pari prestazioni, i codici di ordinazione sono come in tabella ma con ultima cifra 1

CTs at 1A secondary current are also available. The burdens are the same as 5A CTs. The ordering codes are the same as those in the above table but the last figure shall be 1 instead of 5.

#### Esempio / Example

TA.....05 (secondario/secondary 5A) TA.....01 (secondario/secondary 1A)

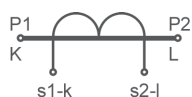

Segnatura morsetti primario e secondario  
Primary and secondary connections marking

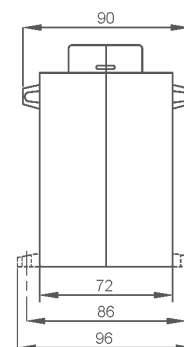
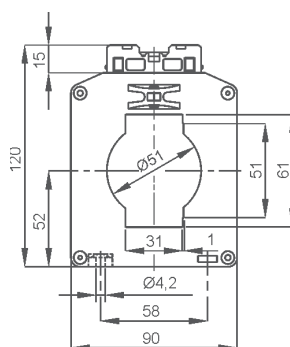

**Tipo con passaggio barra verticale**  
Codici ordinazione come in tabella ma con finale V

**Vertical busbar passing type**  
same ordering codes as shown in table with V at the end

**kg 0,70 ...1,40**

#### NOTE - Note

#### ACCESSORI IN DOTAZIONE

- viti per fissaggio TA alla barra
- cappuccio di protezione per vite fissaggio

#### SUPPLIED ACCESSORY

- CT fixing set for busbar mounting
- protective caps for CT fixing

#### OPZIONI - OPTIONS

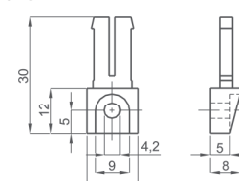
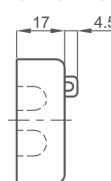
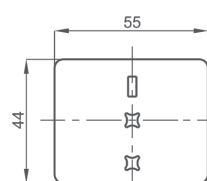

Coprimorsetti sigillabile cod. **9SBMCTA**  
Sealable terminals cover cod. **9SBMCTA**

Piedini di fissaggio cod. **9SAMPDC**  
Fixing feet cod. **9SAMPDC**