

- Diameters 12 - 18 mm •
- Analog with linear current output •
- Cable output •

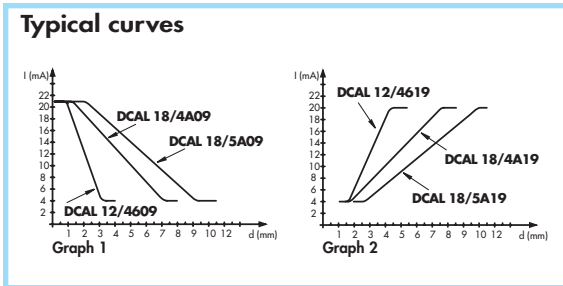
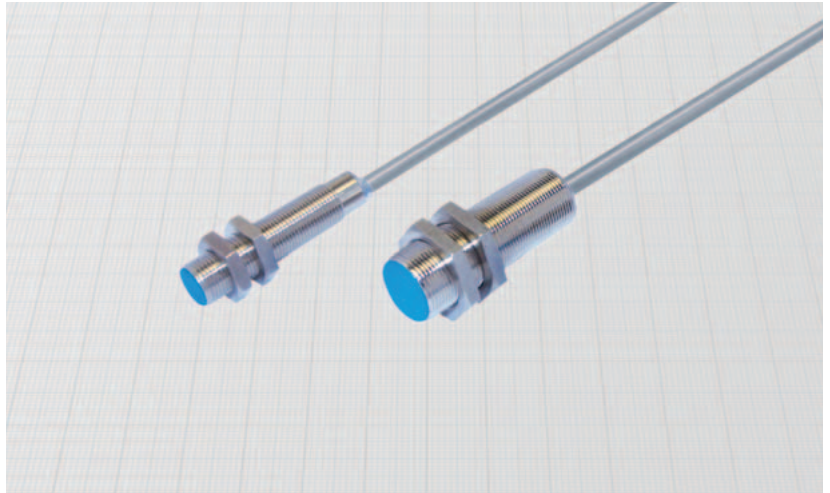
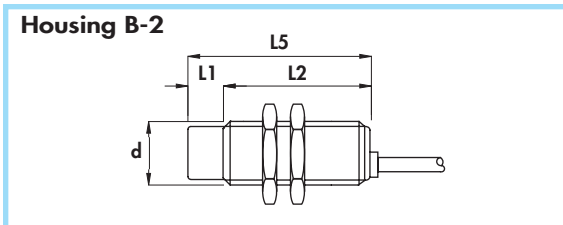
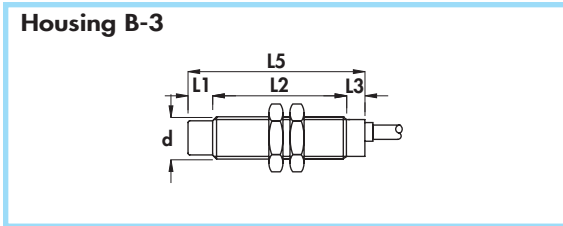

2 wires connection

Vout (V)	RL (ohm)	Vdc (min)
0,4 ... 2	100	12
2 ... 10	500	20
4 ... 20	1000	30

$RL (max) = \frac{(V_{dc}-10) K\Omega}{20}$

3 wires connection

Vout (V)	RL (ohm)	Vdc (min)
0 ... 1	42,5	11
0 ... 10	425	15
0 ... 16	1000	21
0 ... 20	1250	25
0 ... 30	1875	35

$RL (max) = \frac{(V_{dc}-5) K\Omega}{16}$

Diameter		M12 x 1	M18 x 1
Nut	Size	SW17	SW24
	Thickness mm	4	4
Max tightening torque Nm		15	35

- Materials:**
- Cable: 2 m PVC CEI 20 - 22 II; 90°C; 300 V; O.R. shielded
 - Housing: nickel plated brass
 - Sensing face: plastic

General Features:

These inductive proximity sensors provide an output current directly or reversely proportional to the distance between the sensing face and the metal target. The output current is also dependent by the material of the target, so they can be used not only to detect distances, displacements, vibrations and wavings but also to recognize the composition of metals and alloys. In the two wires configuration, they are reversal polarity and short circuit protected devices compliant to the 4-20 mA industrial standard.

Use of the sensor:

The output current flows through the external load RL generating a voltage (V_o) used to drive the input stage of the measuring instrument. The correct value of RL can be chosen accordingly to the values of power supply Vdc and the wanted Vout range as reported on the tables.

Technical data:

- Supply voltage: 10 ÷ 40 Vdc
- Max ripple: 20%
- Output current range: 0 ÷ 16 mA or 4 ÷ 20 mA
- Temperature range: -10° ÷ +70°C
- Max thermal drift: < 10%
- Degree of protection: IP67
- Cable conductor cross section: 0,22 mm² + shield on 12 mm, 0,35 mm² + shield on 18 mm

- Electromagnetic compatibility (EMC) according to EN61000-6-2/-4
- Shock and vibration resistance according to EN60068-2-27 EN60068-2-6

Housing	Flush mounting Non flush mounting	L1	L2	L3	L5	Cable diameter	Body diameter (d)	Linearity error max	No. load supply current	Max switching frequency (F)	Repeat accuracy (R)	Measure range	ORDERING REFERENCES	
		mm	mm	mm	mm								INVERSELY PROPORTIONAL Graph 1	DIRECTLY PROPORTIONAL Graph 2
		mm	mm	mm	mm								mm	mm
B - 3	•	-	43	7	50	4	M12 x 1	5	4	250	0,5	1 ÷ 4	DCAL12/4609	DCAL12/4619
D - 1	•	-	50	-	50	5	M18 x 1	3	4	250	0,5	2 ÷ 7	DCAL18/4A09	DCAL18/4A19
D - 1	•	10	40	-	50	5	M18 x 1	3	4	250	0,5	3 ÷ 9	DCAL18/5A09	DCAL18/5A19

CYLINDRICAL INDUCTIVE SENSORS IN METAL HOUSING

- Diameters 30 - 80 mm
- Analog with linear current output
- Cable output

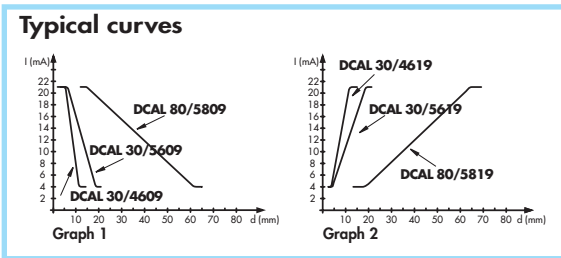
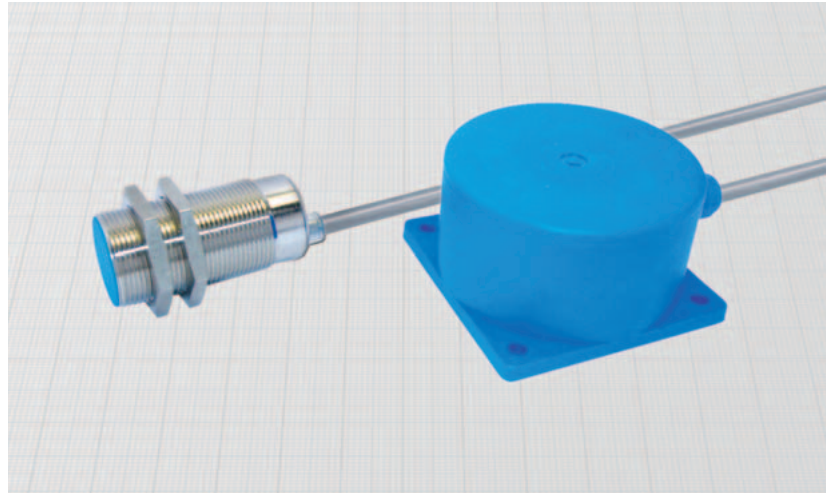
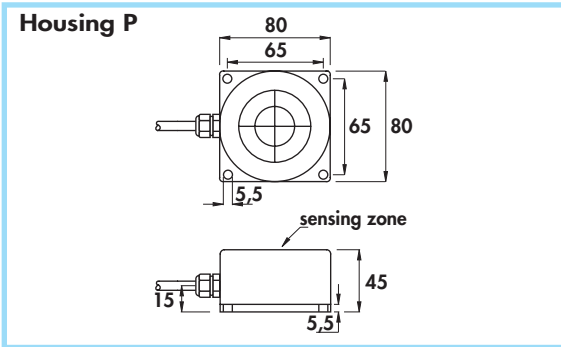
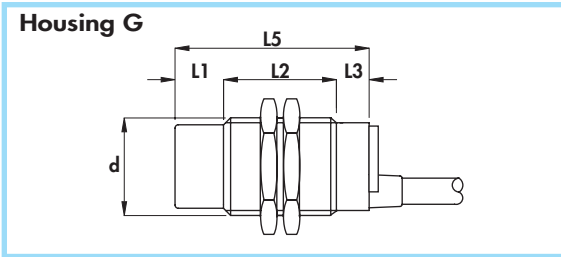

2 wires connection

Vout (V)	RL (ohm)	Vdc (min)
0,4 ... 2	100	15
2 ... 10	500	20
4 ... 20	1000	30

$RL (max) = \frac{(Vdc-10) K\Omega}{20}$

3 wires connection

Vout (V)	RL (ohm)	Vdc (min)
0 ... 1	62,5	11
0 ... 10	625	15
0 ... 16	1000	21
0 ... 20	1250	25
0 ... 30	1875	35

$RL (max) = \frac{(Vdc-5) K\Omega}{16}$

Diameter	M30 x 1,5	
Nut	Size	SW36
	Thickness mm	5
Max tightening torque Nm	80	

Materials:

- Cable: 2 m PVC CEI 20 - 22 II; 90°C; 300 V; O.R. shielded
- Housing 30 mm: nickel plated brass
- Housing 80 mm: plastic
- Sensing face: plastic

General Features:

These inductive proximity sensors provide an output current directly or reversely proportional to the distance between the sensing face and the metal target. The output current is also dependent by the material of the target, so they can be used not only to detect distances, displacements, vibrations and wavings but also to recognize the composition of metals and alloys. In the two wires configuration, they are reversal polarity and short circuit protected devices compliant to the 4-20 mA industrial standard.

Use of the sensor:

The output current flows through the external load RL generating a voltage (V_o) used to drive the input stage of the measuring instrument. The correct value of RL can be choosed accordingly to the values of power supply Vdc and the wanted Vout range as reported on the tables.

Technical data:

- Supply voltage: 10 ÷ 40 Vdc
- Max ripple: 20%
- Output current range: 0 ÷ 16 mA or 4 ÷ 20 mA
- Temperature range: - 10° ÷ + 70°C
- Max thermal drift: < 10%
- Degree of protection: IP67
- Electromagnetic compatibility (EMC) according to EN61000-6-2/-4
- Shock and vibration resistance according to EN60068-2-27 EN60068-2-6

Housing	Flush mounting Non flush mounting	L1	L2	L3	L4	L5	Cable diameter	Body diameter (d)	Max switching frequency (f)	Repeat accuracy (R)	Maximum linearity error	No-load supply current	Measure range	ORDERING REFERENCES	
		mm	mm	mm	mm	mm								INVERSELY PROPORTIONAL Graph 1	DIRECTLY PROPORTIONAL Graph 2
G	•	-	50	10	-	60	5	M30 x 1,5	250	0,5	5	4	4 ÷ 12	DCAL30/4609	DCAL30/4619
G	•	15	35	10	-	60	5	M30 x 1,5	250	0,5	5	4	5 ÷ 18	DCAL30/5609	DCAL30/5619
P	•	-	-	-	-	-	5	80	250	0,5	5	4	20 ÷ 60	DCAL80/5809	DCAL80/5819