

FUZZY Universal Controller with total configuration 1/4 DIN - 96 x 96 mm QF line

Intelligent

The QF universal controller ensures exact control under all conditions even on critical processes, thanks to the FUZZY algorithm control.

Truly universal

Universal input: for thermocouples and resistance thermometers, (°C or °F), mA and Volt (linear or with square root extraction).

Universal output: switching (relay and logic) continuous (mA and Volt) and three point stepping (for electric actuators). Universal control algorithm connecting PID and FUZZY action

The unique, truly universal, all inclusive controller, totally configurable from keyboard and serial interface.



Certified ISO 9001

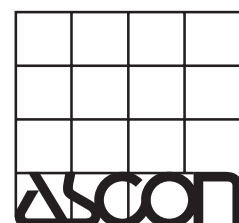

ASCON spa

20021 Bollate - (Milano) Italy - Via Falzarego, 9/11 - Tel. +39 02 333 371 - Fax +39 02 350 4243
<http://www.ascon.it> e-mail info@ascon.it

The QF Series controller

The Intelligence of the **FUZZY** algorithm by ASCON at the service of both process and operator.

For this universal instruments, ASCON has set up an innovative control technique based on **FUZZY** logic combined with standard PID algorithm for the control of industrial processes.

Binary logic

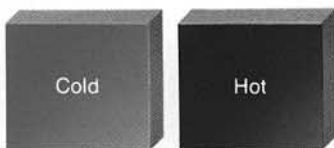

FUZZY shaded logic



WHAT IS **FUZZY**

The **FUZZY** logic, that means "shaded" logic, uses some concepts of artificial intelligence, based upon a block of rules permitting action not determined by binary states (for instance: black/white, open/closed, heat/cool) but on the evaluation of intermediate states (for instance: hot, warm, tepid, cool, cold).

This operating mode is similar to human reasoning, with shades leading to more realistic evaluations and, therefore, better corrective actions.

FROM PID TO **FUZZY**

The standard PID control algorithm uses a mathematical formula to be parameterized (P, I and D values) in function of the characteristics of the process to be controlled (gain and time constants).

By comparison, the **FUZZY** algorithm selects, through a complex group of rules, the mode of action depending upon the process under the various operating conditions, reacting quickly according to the needs.

WHY PID - **FUZZY**

With the QF controller, ASCON offers the maximum control flexibility to the operators.

It's, in fact, possible to freely set the control algorithm starting from the standard PID and combining it with the desired percent of **FUZZY**

PID action integrated by **FUZZY** control is able to react quickly and without unwanted oscillations to load and set point changes.

PID-**FUZZY** combination allows good control of difficult processes, especially in the presence of changes to the operating conditions, it makes possible the control of very critical processes, practically impossible to control with the standard PID.

Comparison of step response curves between PID algorithm and ASCON **FUZZY** algorithm in different operating conditions.

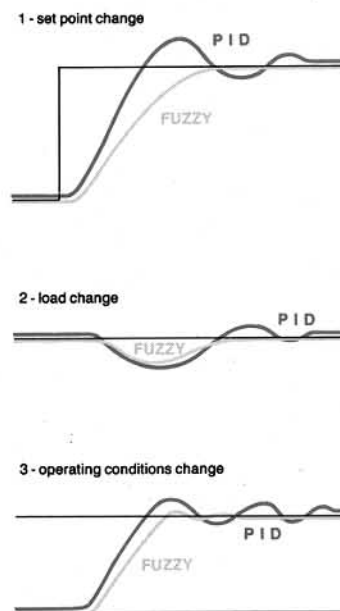

Note: PID parameters have been optimized before the change.

The controller computes automatically the **FUZZY** parameters, starting from the set PID parameters. The factory set PID-**FUZZY** parameters are applicable for the most part of processes. Automatic searching and loading of the optimum values can be carried out through the launching of the automatic self-tuning procedure. The PID-**FUZZY** combination is a truly universal control algorithm suitable to control efficiently any process. Only one controller for all the applications at the service of both process and operator.



Auxiliary power supply
For external transmitter.

Universal power supply
from 100 to 240 Vac or 24 Vac or 24 Vdc.

Isolated auxiliary output Y6.
Optional.
For the retransmission of process value, set point or as second control output.

3 logical inputs
For the change of the operating modes - Auto/man, Loc/Rem, recall of one of the 3 stored set points and keyboard lock.

Total configurability from keyboard and serial communication
All possible functions are standard, the controller only needs to be configured according to the application. Total configurability allows setting up of: type of control, input, scale range, type of main control output with safety state, set point, 2 auxiliary outputs and retransmission output.

Set Point
The instrument can operate with Local Set point, Remote set point, or with a set point selected between 3 stored values.
Set point change can be gradual, setting up and down desired gradient.

Serial communication.
Optional. RS485 Port for the complete access to the instrument.

Universal input
For thermocouples (J,L,T,K,S,R,B) and Pt100Ω (°C or °F).
For standard dc signals in mA or Volt (linear or with square root extraction).

Main universal output
Galvanically isolated, with single or dual action (Heat-Cool), to select within the 5 built-in possible functions: relay, logic, continuous (mA or Volt) and three point stepping.

2 relay auxiliary outputs
With independent, deviation or band set point. With Burnout function.

Maximum protection
Very high immunity to interference, guided procedures and 3 different access level to parameters. Front protection IP54 or IP65.

truly Universal,
all included and.....
...with **FUZZY** control

Technical data

FREELY CONFIGURABLE

It is possible sequentially set and choose the following functions with keys and serial communication: type and control strategy, type of input and output signals, control parameters.

UNIVERSAL INPUT

Input type, scale range	
Pt100 Ω at 0°C Thermoresistance	-200...600 °C -328...1112 °F
	-99.9...300.0 °C -99.9...572.0 °F
J Thermocouple Fe-Cu 45% Ni	0...600 °C 32...1112 °F
L Thermocouple Fe-Cu/Ni	0...600 °C 32...1112 °F
T Thermocouple Cu - CuNi	-200...400 °C -328...752 °F
K Thermocouple Cromed Alumel	0...1200 °C 32...2192 °F
S Thermocouple Pt10% Rh-Pt	0...1600 °C 32...2912 °F
R Thermocouple Pt13% Rh-Pt	0...1600 °C 32...2912 °F
B Thermocouple Pt30% Rh-Pt6%Rh	400...1800 °C 752...3272 °F
4..20mA, 0..20mA	Configurable eng. units *
0..50mV, 0..200mV	
0..1V, 1..5V, 0..5V	
0...10V	

* Linear or with square root extraction and decimal point selection

Common features

- A/D converter: 50.000 points
- Sampling time: 0,5...30 sec.
- For change of power supply within 100 and 240 Vac the error is negligible
- Input shift: -60 ... + 60 digits
- Measure filtering: 0...30 sec

For thermocouples (IEC 584)

- Cold junction built-in
- Line resistance: 15 Ω max
- Accuracy: 0,2% \pm 1°C at 25 °C
- Measurements drift:
< 2 μ V/°C ambient temperature
< 5 μ V/10 Ω line resistance

For Pt100 thermoresistance (IEC 751)

- 2 or 3 wire connection
- Line resistance:
20 Ω max for 3 wire connection
- Accuracy: 0,2% at 25°C
- Measurement drift:
< 0,1°C/10°C ambient temperature
< 0,5°C/10 Ω line resistance (3 wire)

Standard dc signals

- Input resistance:
current: 30 Ω ; voltage: 10M Ω for mV,
10K Ω for V
- Accuracy: 0,1% at 25°C
- Measurement drift:
< 0,1%/20°C ambient temperature

AUXILIARY INPUTS

- 3 logic inputs by the maintained closure of different combinations of remote contacts the following selections are possible:
- Auto/Man
- Local/Remote Set Point
- One out of the 3 stored set points
- Keyboard lock.

MAIN UNIVERSAL OUTPUT Y1

Can be configured as follows:

- single or dual
 - direct or reverse action
 - upper and lower limits: 10...100%
 - adjustable output speed: 0...20%/sec
- Following features are always present:

Relay: 1 NO contact, 5A/250 Vac

Logic voltage:

0/22 Vdc \pm 10%, 20 mA max
Isolation: 500Vac/1' referred to input

Continuous

Resolution: 12bit (0,025%)
Accuracy: 0,1% at 25°C
Isolation: 500 Vac/1' referred to input
Short circuit protection
- direct current: 0...20 mA, 4...20 mA
750 Ω (10Vdc max)
- direct voltage: 1...5V, 0...5V
500 Ω (20 mA max)

Three point stepping (for electric actuators)

3 positions: open-stop-close
2 interlocked NO contacts, 5A/250 Vac

Dual action

For processes with "dual action" output Y1 (for example Heat-cool), two outputs are available with the following possible combinations:

Y1 Heat	R	L	R	C	R	C	L	C
Y1 Cool	R	R	L	R	C	C	C	L

R = Relay; L = Logic;
C = Continuous (mA or Volt);

When Y6 continuous output is used for Y1 cool, the retransmission output is not available.

AUXILIARY OUTPUTS Y2, Y3 AND Y6

Y2 and Y3 actions (see fig. 2)

For Y2 and Y3 the following functions are configurable:

- The control mode: active high or active low (i.e. relay energized above or below the threshold)
- The type of set point (in respect of W1)
- Deviation: from -300 to + 300 digits
- Independent: within the scale span
- Band: from 0 to 300 digits (with or without startup inhibition, see fig. 3)
- Burn Out function
- Output: 1 NO contact, 5A/250 Vac
- Hysteresis: from 0,01 to 10.00%

Note - The setting range of set point for Y2 and Y3 is not limited by the limits of main set point W1 but only by the scale ends.

Y6 auxiliary analog output

For the following configurable functions:

- process variable (X) retransmission
- set point (W) retransmission
- Y1 output retransmission
- Y1 (heat) output retransmission
- Y1 (cool) output for control or retransmission functions
- Accuracy: 0,1% at 25°C
- Signal characteristic equal to Y1 continuous output.

UNIVERSAL CONTROL

The control algorithm features On-Off, PID-FUZZY, PID (I and D actions can be excluded).

Parameters:

- Proportional band: from 0,5 to 1000%
- Integral time: from 0,1 to 100 minutes
- Derivative time:
from 0,01 to 10 minutes
- Fuzzy intensity: from 0 to 90%

For On-Off control with hysteresis

- Hysteresis: from 0,1 to 10%

For time proportional control

- Cycle time: from 1 to 200 seconds

For dual action control

- Cycle time and output limits can be separately set for the 2 channels
- Dead zone between the two control actions:
from \pm 5,0% of Y1 (see fig.1)
- Gain for Y1 cool output: 0,1...3,0

Fig. 1: Output characteristic for dual action controllers. Example: Heat - Cool

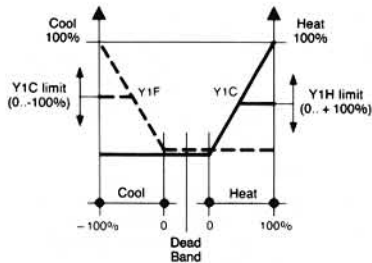

Y1C = Cool output (---)
Y1H = Heat output (—)
Indication for Y1: -100%... + 100%

Fig. 2: Auxiliary control outputs Y2 and Y3

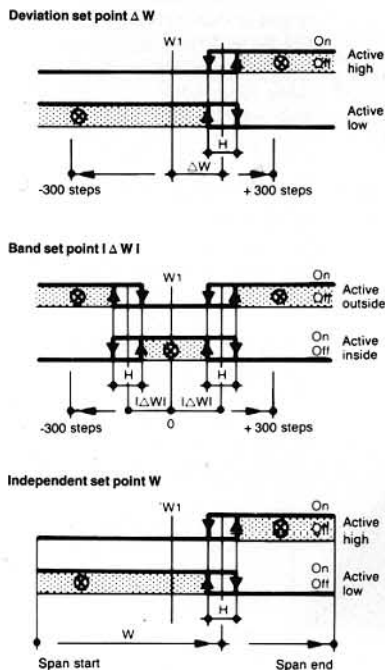

Note:
W1: Main set point
H: Auxiliary outputs hysteresis

Fig. 3: Example of Bias and Ratio setting for a Controller with scale range 0...500 bar

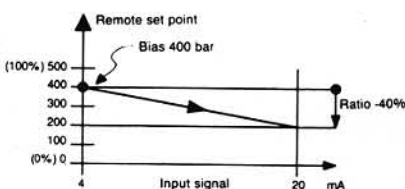

For three point stepping control

- Actuator response time: from 15 to 600 sec.
- Minimum correction step: from 0,1 to 10% of the useful travel (resolution on positioning)
- Potentiometer (for position retransmitting only): 100...10 kΩ (with possible automatic calibration).

“IN TUNE”

The P.I.D. parameters are computed by the method known as “Natural Frequency” type. The tuning may be effected on the occasion of a change of Set Point or during process steady conditions. The tuning is started on operator request and when the parameters computation is completed is automatically switched off (one-shot).

SET POINT

It's possible to set:
- upper and lower limits
- up and down gradients (digits/min) between 0,0...10% of scale range

Remote set point (see fig. 3)

- 2 parameters allow:
- setting of bias, in engineering units
- setting of ratio, from -100 to 100%
- Input: 4...20 mA, 0...20 mA (Ri 30Ω)
1...5V, 0...5V, 0...10V (Ri 300KΩ)
- Accuracy: 0,1% at 25°C

Stored set points

- Up to 3 values, that can be recalled from keyboard, logic contacts or serial interface

AUTO/MAN STATION

- Built-in with bumpless action
- AUTO/MAN change via keyboard, logic input or serial interface

POWER SUPPLY FOR TRANSMITTER

- To supply a two wire transmitter 4...20 mA or a 3 wire 24 Vdc transmitter

SERIAL COMMUNICATION

- RS485 Port
- Modbus Jbus Protocol
- Baud rate configurable among: 1200, 2400, 4800, 9600 Bit/s
- Address from 1 to 247

PROTECTIONS

- Input: the measure overrange or a failure on the input line (break or short

circuit) is displayed and forces the outputs to the value of the safety state selected within configuration.

- Safety state:
Main output Y1: -100... + 100%
Auxiliary outputs Y2 and Y3: 0 to 100% or disabled
- Parameters: are password protected and divided into 4 groups configurable as:
- visible and alterable
- visible but not alterable
- masked and not alterable

GENERAL CHARACTERISTICS

- Power supply:
100..240 V, 50/60 Hz, -15 + 10% (250V max) or 16...28V, 50/60 Hz and 20...30 Vdc
Power consumption: 4 VA max
- Isolation to EN 61010
Power supply with double isolation
Degree of pollution: 1
Installation category II
- EMC for CE mark for industrial environments.
- Climatic category:
KWF 40040
- Ambient operating temperature:
0...50°C
- Protection mode to DIN 40050
front panel: IP54
housing: IP30
terminals: IP20
- Housing material UL94 V1
- Weight: approx. 0,75 kg
- Dimensions: 96 x 96 dept 150 mm (behind the panel)

Connections and fitting dimensions

CONNECTIONS

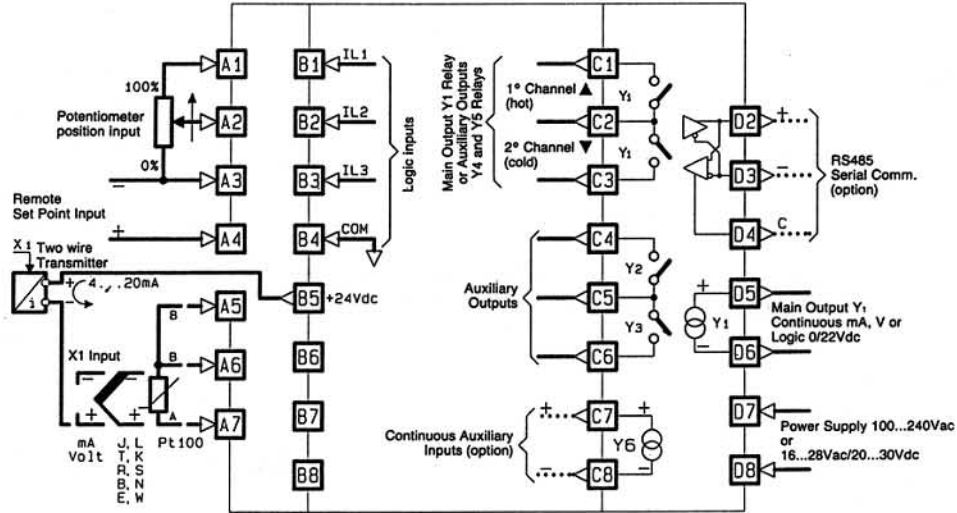

Notes:

- To supply a 3 or 4 wire transmitter, use terminals B5 (+) and A6 (-)
- Main control output Y1 can be selected within the 5 built-in possible functions: relay (terminals C1 and C2), logic or continuous 4...20 mA or 0...10 Volt (terminals D5 and D6) and three point stepping (terminals C1, C2 and C3).

OVERALL DIMENSIONS

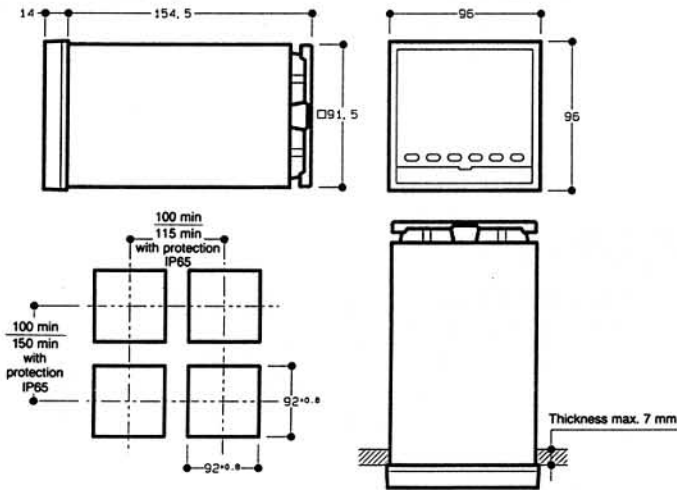

FRONT PROTECTION KIT IP65: mod. F10-435-2A101

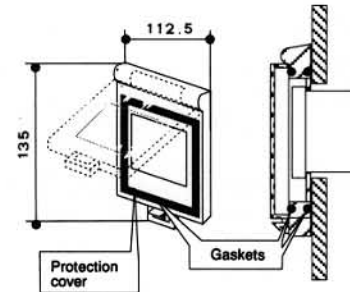

Ordering Codes



Power supply	A
100...240 V 50/60 Hz	3
16...28 V 50/60 Hz and 20...30 Vdc	5

Serial communication (option)	B
None	0
Fitted RS485 Modbus-Jbus protocol	3

Auxiliary Analog Output Y ₆ (option)	C
None	0
Fitted 0/4...20mA, 0/1...5V, 0...10V	1